



PUMTECH KOREA

Cosmetic Containers Catalogue



PUMTECH

Growing up with customers.

Pumps & Bottles Catalogue

for Cosmetics

ABOUT PUMTECH KOREA

Pum-tech Korea was founded as a company specialized in producing cosmetics dispensers and airless packages in 2001. Since its foundation, the company has developed unique products with new functions and fresh designs. And thanks to continuing efforts on improving quality and innovative products, Pum-Tech Korea has become to provide the best quality products and service to major customers in the local as well as the overseas market in 10 years.

Together with its mother company, BooKuk T&C, who the first Korean manufacturer of pharmaceutical and cosmetic tubes established in 1969, Pum-tech Korea has worked for its top priority of customers' satisfaction. To this end, the company has established and operated the production and the management system to meet the customer-desired product quality, the delivery and top-quality service. Pum-tech Korea has been doing its best efforts under the slogan 'Growing up with Customers' expressing the company's will to develop further together with the customers.

Pum-tech Korea analyzes the rapidly changing cosmetic market trends and continues new challenges to even create a new trend. By doing so, the company has invested a lot in R&D activities that support flawless quality production and new product development offering a fresh experience of products use to end-users. Pum-tech Korea also explores many ways to grow together with its partners firm in the long term while continuing its investment in partner company assistance.

Pum-tech Korea will continue such efforts not only for its own growth but also clients and the cosmetics industry as a whole and furthermore, the company will invest its efforts to become a healthy enterprise fulfilling its social responsibilities including more job creation.

HISTORY

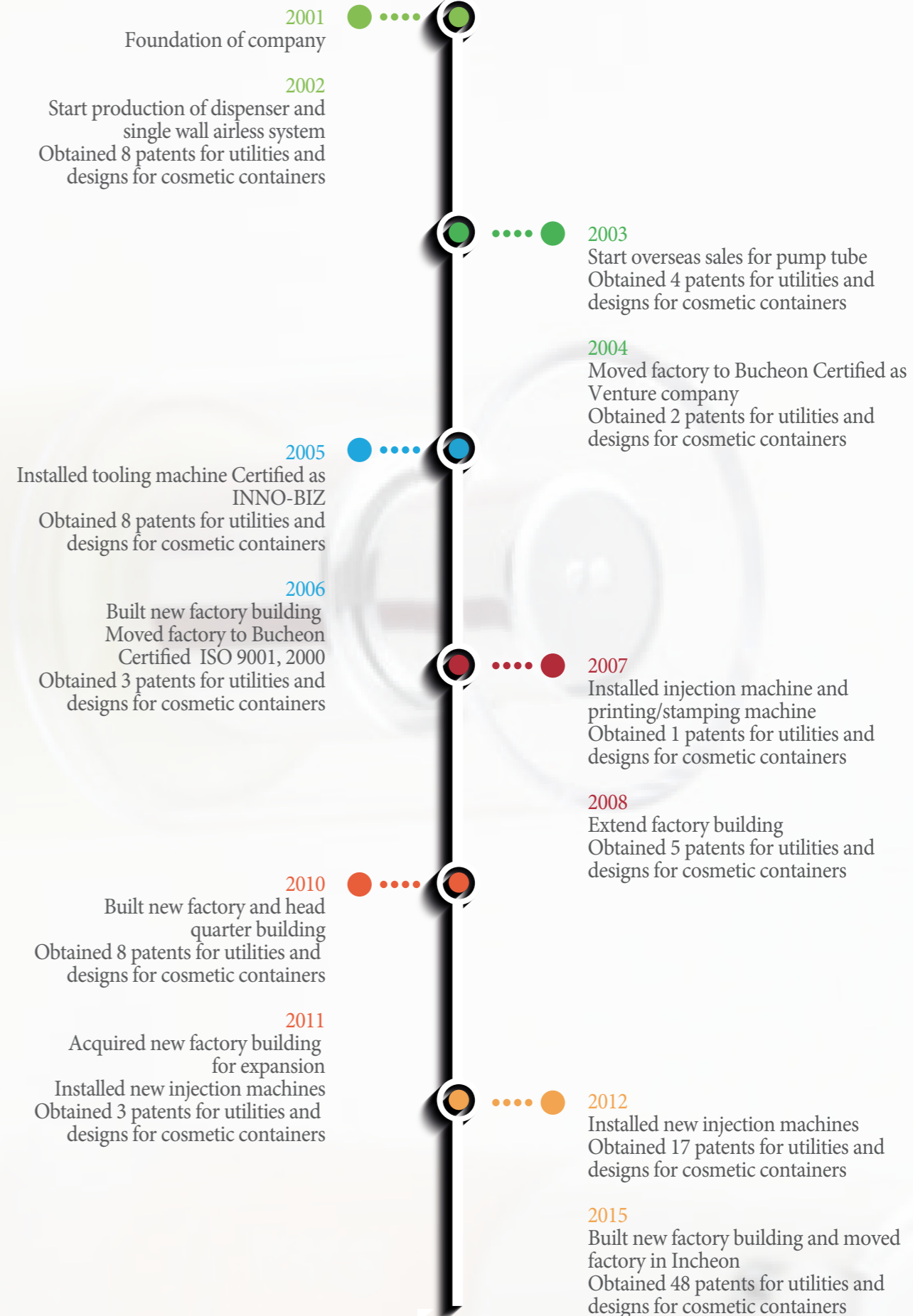



CONTENTS

■ SWA LINE (Single Wall Airless)	page 08-23
■ JUMBO LINE	page 24-29
■ MINI & SPOT LINE	page 30-35
■ DWA LINE (Double Wall Airless)	page 36-45
■ JAR & DROPPER LINE	page 46-51
■ AIRLESS COMPACT	page 52-61
■ AIRTIGHT COMPACT	page 62-69
■ TUBE & POUCH LINE	page 70-75
■ VARIOUS DESIGNS	page 76-79
■ DISPENSERS	page 80-83

SWA LINE
Single Wall Airless



Collar Pump / Disk Base

As a most classic design,
 Various appearances can be created with broad range of decorating options.
 Two types of bases and a wide range of size options can be selectable depends on requirements.



Collar Pump / Disk Base Series

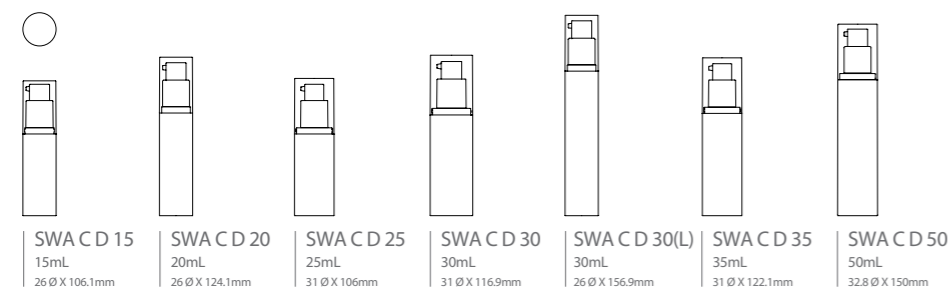

Part Material
 • Over Cap : SAN / ABS / PETG • Actuator : PP • Container Cap : PP • Bottle : SAN / PETG • Base : ABS / HIPS / PETG

Collar Pump / Rim Base

As a most classic design,
 Various appearances can be created with broad range of decorating options.
 Two types of bases and a wide range of size options can be selectable depends on requirements.



Collar Pump / Rim Base Series

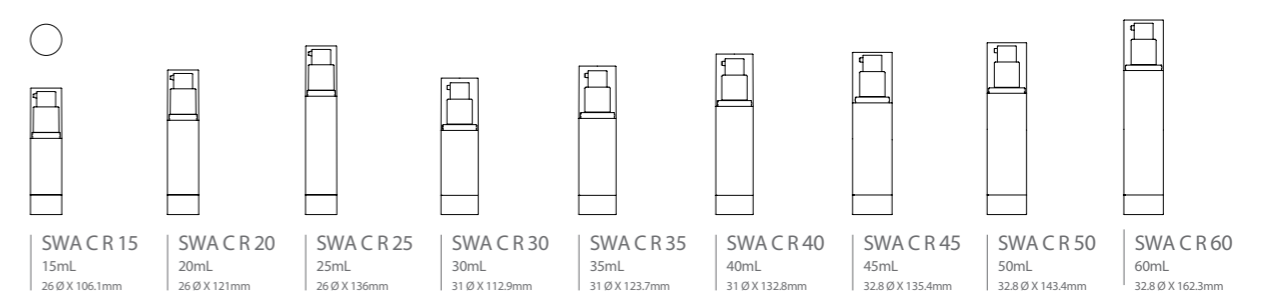

Part Material
 • Over Cap : SAN / ABS / PETG • Actuator : PP • Container Cap : PP • Bottle : SAN / PETG • Base : ABS / HIPS / PETG

Shoulder Pump / Disk Base

As a most classic design,
 Various appearances can be created with broad range of decorating options.
 Two types of bases and a wide range of size options can be selectable depends on requirements.



Shoulder Pump / Disk Base Series

SWA S D 15 15mL 26 Ø X 113.5mm	SWA S D 20 20mL 26 Ø X 129.7mm	SWA S D 25 25mL 31 Ø X 113mm	SWA S D 30 30mL 31 Ø X 122.2mm	SWA S D 30(L) 30mL 26 Ø X 162.5mm	SWA S D 35 35mL 31 Ø X 129mm	SWA S D 50 50mL 32.8 Ø X 152.4mm

Part Material
 • Over Cap : SAN / ABS / PETG • Actuator : PP • Shoulder : ABS • Bottle : SAN / PETG • Base : ABS / HIPS / PETG

Shoulder Pump / Rim Base

As a most classic design,
 Various appearances can be created with broad range of decorating options.
 Two types of bases and a wide range of size options can be selectable depends on requirements.



Shoulder Pump / Rim Base Series

SWA S R 15 15mL 26 Ø X 112.9mm	SWA S R 20 20mL 26 Ø X 127.7mm	SWA S R 25 25mL 26 Ø X 145.2mm	SWA S R 30 30mL 31 Ø X 120.8mm	SWA S R 35 35mL 31 Ø X 129.2mm	SWA S R 40 40mL 31 Ø X 141mm	SWA S R 45 45mL 32.8 Ø X 142mm	SWA S R 50 50mL 32.8 Ø X 149.8mm	SWA S R 60 60mL 32.8 Ø X 168.8mm

Part Material
 • Over Cap : SAN / ABS / PETG • Actuator : PP • Shoulder : ABS • Bottle : SAN / PETG • Base : ABS / HIPS / PETG

EL Pump / Disk Base

The world's first "Overcap-less" stock mold design for airless pump.
The sophisticated design can make your cosmetic line much fabulous.



EL Pump / Disk Base Series

SWA EL D 15 15mL 26 Ø X 106.6mm	SWA EL D 20 20mL 26 Ø X 123.2mm	SWA EL D 25 25mL 31 Ø X 107.5mm	SWA EL D 30 30mL 31 Ø X 116.7mm	SWA EL D 30(L) 30mL 26 Ø X 156mm	SWA EL D 35 35mL 31 Ø X 123.5mm	SWA EL D 50 50mL 32.8 Ø X 146.8mm

Part Material
• Actuator Cover : ABS • Inner actuator : PP • Shoulder : ABS • Bottle : SAN / PETG • Base : ABS / HIPS / PETG

EL Pump / Rim Base

The world's first "Overcap-less" stock mold design for airless pump.
The sophisticated design can make your cosmetic line much fabulous.



EL Pump / Rim Base Series

SWA EL R 15 15mL 26 Ø X 106.8mm	SWA EL R 20 20mL 26 Ø X 121.4mm	SWA EL R 25 25mL 26 Ø X 136.3mm	SWA EL R 30 30mL 31 Ø X 113.7mm	SWA EL R 35 35mL 31 Ø X 123.7mm	SWA EL R 40 40mL 31 Ø X 133.7mm	SWA EL R 45 45mL 32.8 Ø X 136.2mm	SWA EL R 50 50mL 32.8 Ø X 144.4mm	SWA EL R 60 60mL 32.8 Ø X 163.1mm

Part Material
• Actuator Cover : ABS • Inner actuator : PP • Shoulder : ABS • Bottle : SAN / PETG • Base : ABS / HIPS / PETG

R Pump / Disk Base, Rim Base

Various pump and bottle designs,
Various appearances can be created with broad range of decorating options.



R Pump / Disk Base, Rim Base Series

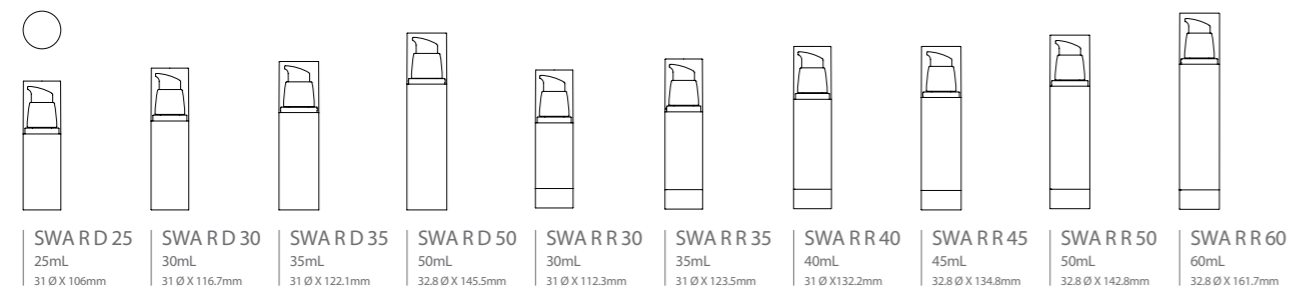

Part Material
• Over Cap : SAN / ABS / PETG • Actuator : PP • Shoulder : ABS • Bottle : SAN / PETG • Base : ABS / HIPS / PETG

Bell Type / Oval Type / I Type

Various pump and bottle designs,
Various appearances can be created with broad range of decorating options.



Bell Type / Oval Type / I Type

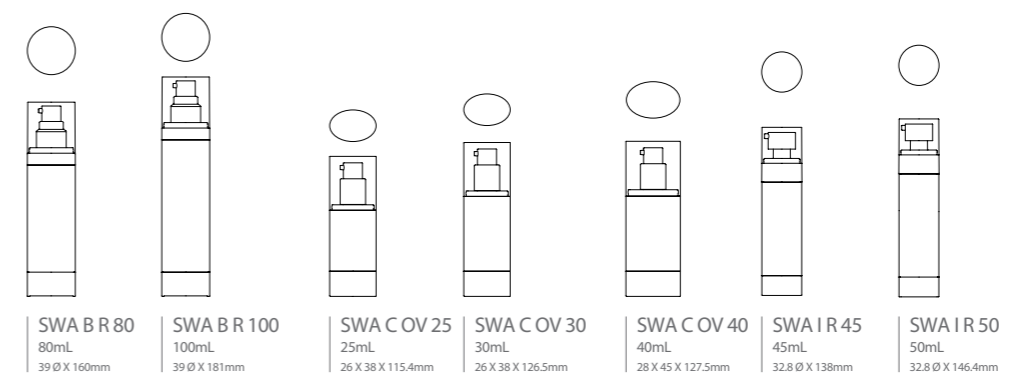

Part Material
• Over Cap : SAN / ABS / PETG • Actuator : PP • Container Cap : PP • Bottle : SAN / PETG • Base : ABS / HIPS / PETG

GR Series

Most common but essential containers in cosmetics.



GR Series

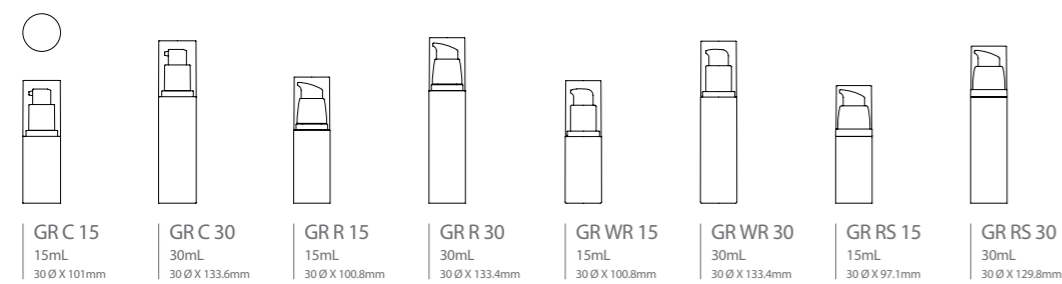

Part Material
• Over Cap : PETG • Actuator : PP • Shoulder (R, RS) : ABS • Shoulder (C, WR) : PP • Bottle : PP • Base : HIPS

JP Series

Simple and basic with airless and dip-tube type. Wide ranges of options are available.



JP Series

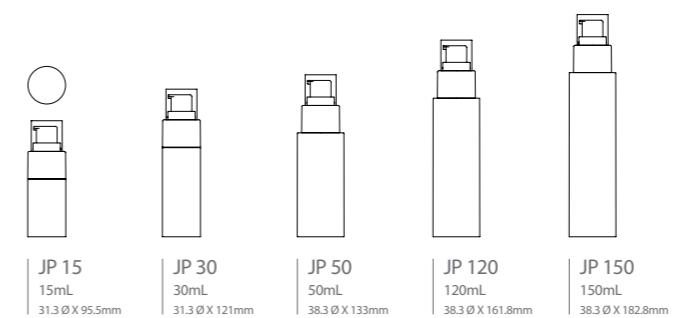

Part Material
• Over Cap : PP • Actuator : PP • Shoulder : PP • Bottle : PP • Base : HIPS

JJ Series

Jumbo style PP airless with two types of pump design.



JJ Series

WB 1 Series

New eco-friendly concept of cosmetic containers to fine tune your brand offering.



WB 1 Series

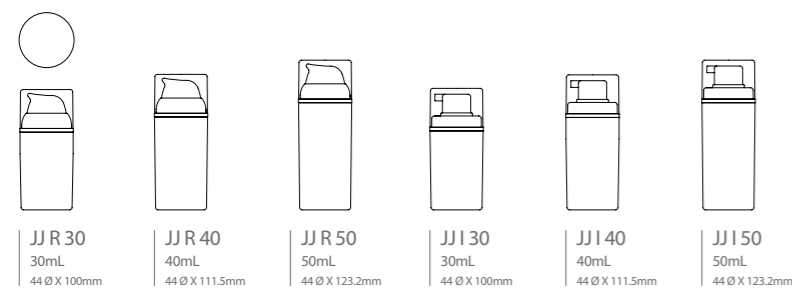

Part Material
• Over Cap : PP • Actuator : PP • Shoulder : PP • Bottle : PP

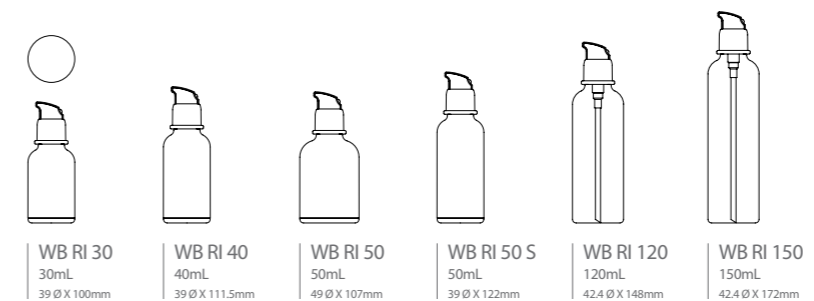

Part Material
• Clip : PP • Actuator : PP • Bottle : SAN / PETG • Base : PETG • Shoulder : PETG

WB 2 Series

Classical glass-shaped skincare line including airless systems and blow moulded bottle.



WB 2 Series

WB 3 Series

Newly designed full line-up skincare series including airless systems, blow moulded bottles, dropper and jar.



WB 3 Series



Part Material
• Over Cap : PP/PETG • Actuator : PP • Shoulder : PP • Bottle : PP/PETG • Base : PETG

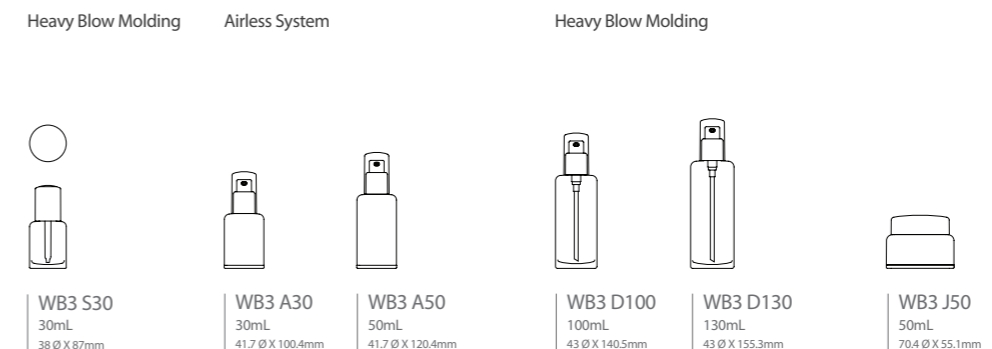

Part Material
• Over Cap : PETG/ABS • Actuator : ABS • Shoulder : ABS • Bottle : PETG • Base : ABS • Dropper Pipette : PETG



JUMBO LINE

Side Button Airless Series

New concept for liquid formulas. Customers can use the contents directly without a finger using various puffs on the top of the pump. Dish type (not using an applicator) and brush type are also available.

New Jumbo & New Jumbo Mini Series

NEW JUMBO : Take advantage of a wide range of options for creating unmistakable look. Two kinds of pumps with big PP bottles offer exclusively young and dynamic style. NEW JUMBO MINI : Mini version of New Jumbo Line.



Side Button Airless Series

New Jumbo & New Jumbo Mini Series

Sponge Type

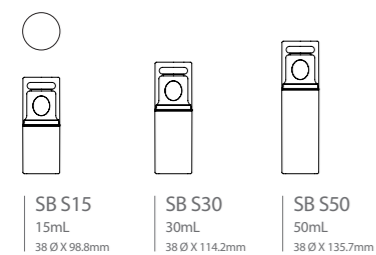

SB S15 15mL 38 Ø X 98.8mm	SB S30 30mL 38 Ø X 114.2mm	SB S50 50mL 38 Ø X 135.7mm
--	---	---

Dish Type

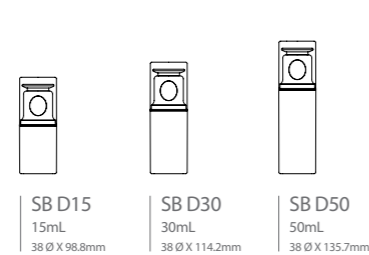

SB D15 15mL 38 Ø X 98.8mm	SB D30 30mL 38 Ø X 114.2mm	SB D50 50mL 38 Ø X 135.7mm
--	---	---

Brush Type

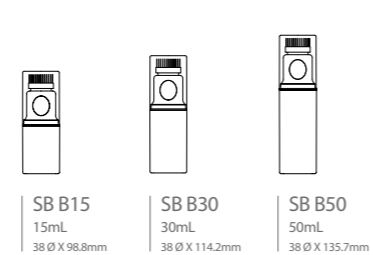

SB B15 15mL 38 Ø X 98.8mm	SB B30 30mL 38 Ø X 114.2mm	SB B50 50mL 38 Ø X 135.7mm
--	---	---

Part Material
• Over Cap : PP/PETG • Actuator : ABS • Shoulder : PP • Bottle : PP/PETG • Sponge Base : ASA • Sponge : NBR • Dish : PP

New Jumbo Series

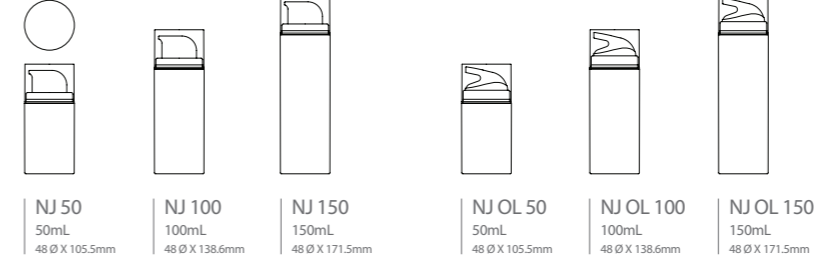

NJ 50 50mL 48 Ø X 105.5mm	NJ 100 100mL 48 Ø X 138.6mm	NJ 150 150mL 48 Ø X 171.5mm	NJ OL 50 50mL 48 Ø X 105.5mm	NJ OL 100 100mL 48 Ø X 138.6mm	NJ OL 150 150mL 48 Ø X 171.5mm
--	--	--	---	---	---

New Jumbo Mini Series

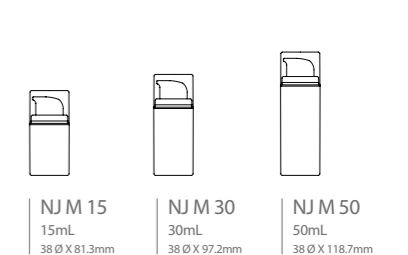

NJ M 15 15mL 38 Ø X 81.3mm	NJ M 30 30mL 38 Ø X 97.2mm	NJ M 50 50mL 38 Ø X 118.7mm
---	---	--

Part Material
• Over Cap : PP • Actuator : PP • Shoulder : PP • Bottle : PP

R Jumbo Series

R shape pump with single wall and double wall airless. Many decoration options are available.



R Jumbo Series

EL Jumbo Series

Wide range of size options from 30ml to 200ml and many decoration options are available. Exclusively young and dynamic in design, form, colour and finish.



EL Jumbo Series

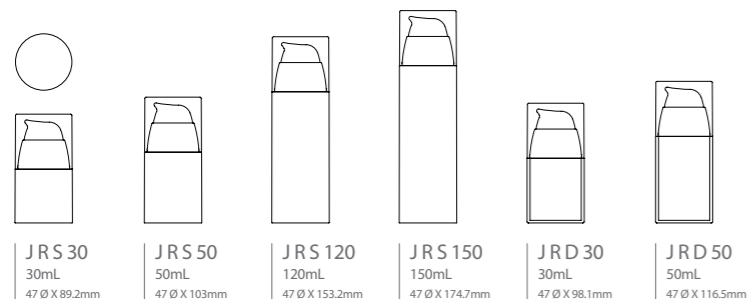

Part Material
• Over Cap : SAN/ABS/PETG • Actuator : PP • Shoulder : ABS • Single/Inner Bottle : PP • Outer Bottle : SAN/PETG • Base : HIPS/PETG

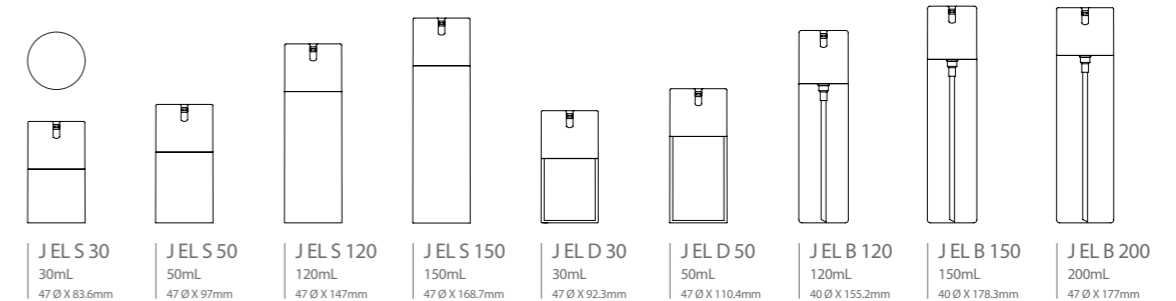

Part Material
• Actuator Cover : ABS • Inner Actuator : PP • Shoulder : ABS • Bottle : PP, SAN/PP, PETG • Base : HIPS

MINI & SPOT LINE



Mini Airless & Ampoule Series

Various shapes and sizes for mini and ampoule containers.



Mini Airless / Ampoule Series

Double Mix Series

Securing two formulas separately and mixing them with only one action!



Double Mix Series

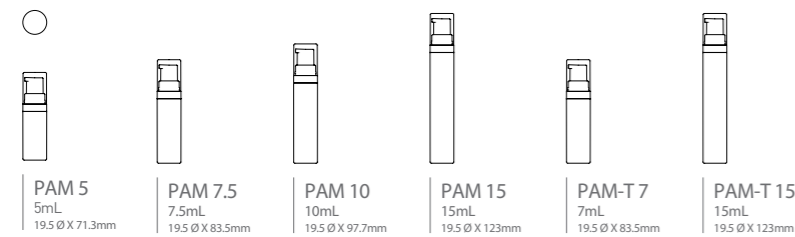

Part Material
• Over Cap : PP/ABS • Actuator : PP • Shoulder : PP • Bottle : PP/PETG

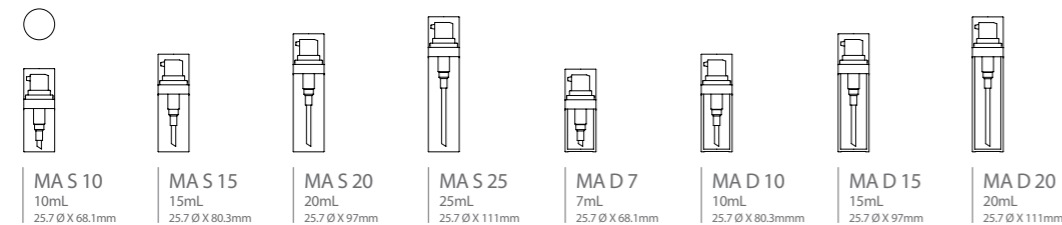

Part Material
• Over Cap : SAN/ABS/PETG • Actuator : PP • Shoulder : PP/PETG • Inner Bottle : PP • Outer Bottle : SAN

The original double mix is a small ampoule with two separate chambers. The inner chamber opens automatically when the actuator is firstly pushed. The twist double mix offers more visible mixing action. The hidden chamber in the bottom goes up and opens when the base is twisted.

Double Mix Ampoule

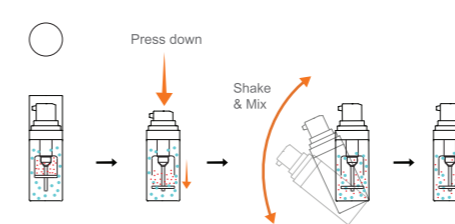

D-MIX
liquid:8ml / powder:1g
25.5 Ø X 81mm

Part Material
• Over Cap : PETG • Actuator : PP • Shoulder : PP/PETG/ABS • Bottle : SAN/PETG • Base : ABS

Twist Double Mix

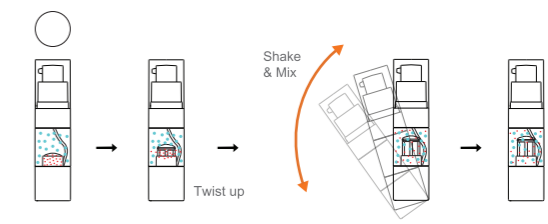

T-D-MIX
liquid:9ml / powder:1.2g
27.3 Ø X 108.2mm

Spot Mini Series

Various shapes and sizes for spot care products.
New transparent bottles are available, too.



Spot Mini Series

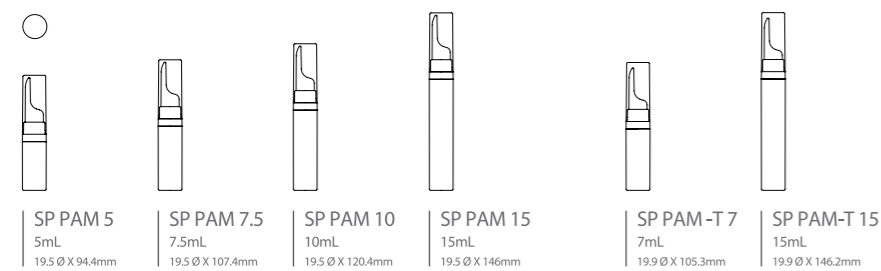

Part Material
• Over Cap : PP/PETG • Actuator : PP/PE • Shoulder : PP • Bottle : PP/PETG

Spot Series

Various shapes and sizes for mini and spot, Ampoule containers.
As a "Finger-Free" concept, three types of actuators can be applied for all spot bottles to meet customer's needs.



Spot Series

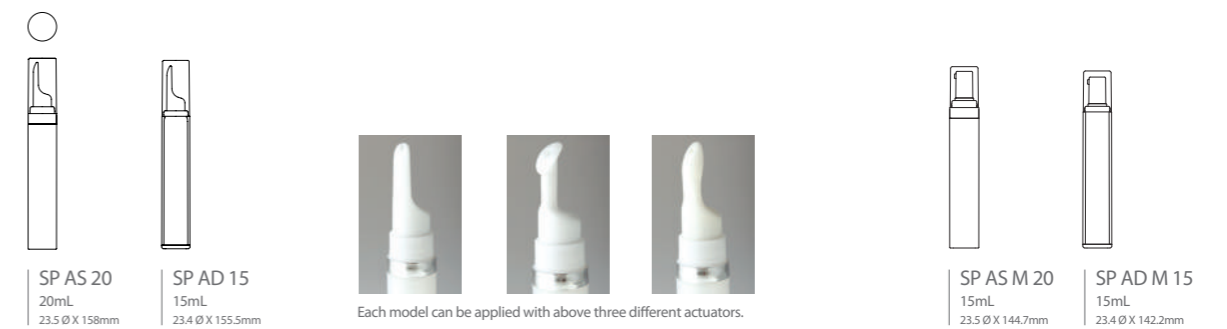

Part Material
• Over Cap : PETG • Actuator : PP/PE • Shoulder : PP • Bottle : SP AS-PP/SP AD-Inner : PP, Outer : SAN

DWA LINE

Double Wall Airless



PT Series

Most symbolic design of Pumtech Korea.
It's also world's first "over-cap less" stock mold design for airless pump as dual structure.



PT Series

DB Series

Luxurious "over-cap less" stock mold design for airless pump as dual structure.
The sophisticated design can make your cosmetic line much fabulous.



DB Series

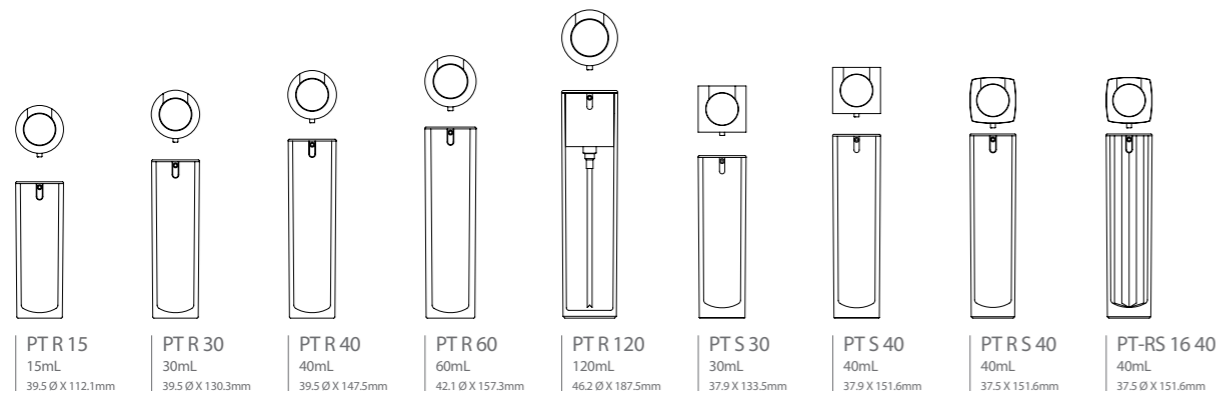

Part Material
• Actuator Cover : ABS • Inner Actuator : PP • Shoulder : ABS • Inner Bottle : PP • Inner Bottle (PT R 120/200) : PETG • Outer Bottle : SAN/PETG

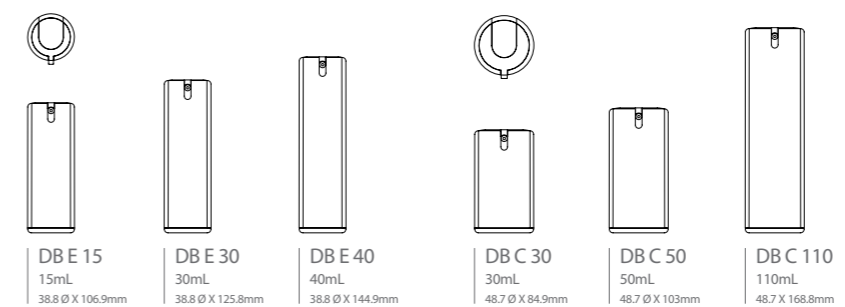

Part Material
• Actuator Cover : ABS • Inner Actuator : PP • Shoulder : ABS • Inner Bottle : PP • Inner Bottle (DB C 120) : PETG • Outer Bottle : SAN • Base : ABS

LC Series

Full line-up including jars and two kinds of over cap make your product line distinctive.



LC Series

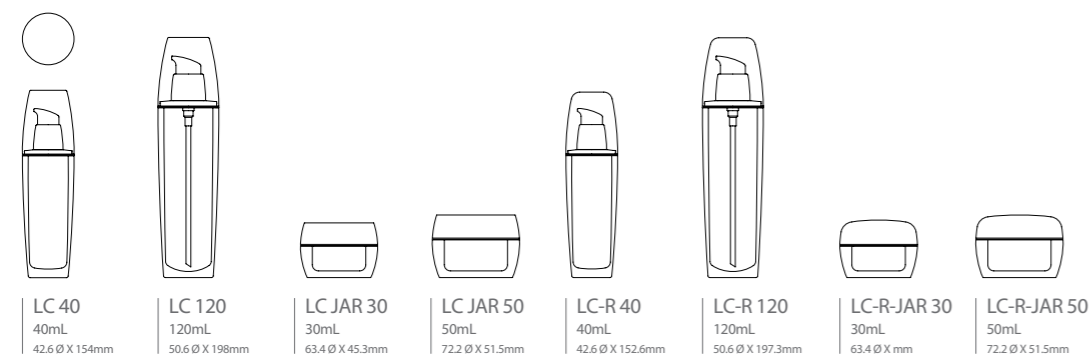

Part Material
• Over Cap : PETG • Actuator : PP • Shoulder : ABS • Inner Bottle : PP • Outer Bottle : SAN

CN Series

Full line-up skincare series. Simple design as hiding shoulder inside of the over cap. Heavy wall and bottom make your product luxurious.



CN Series

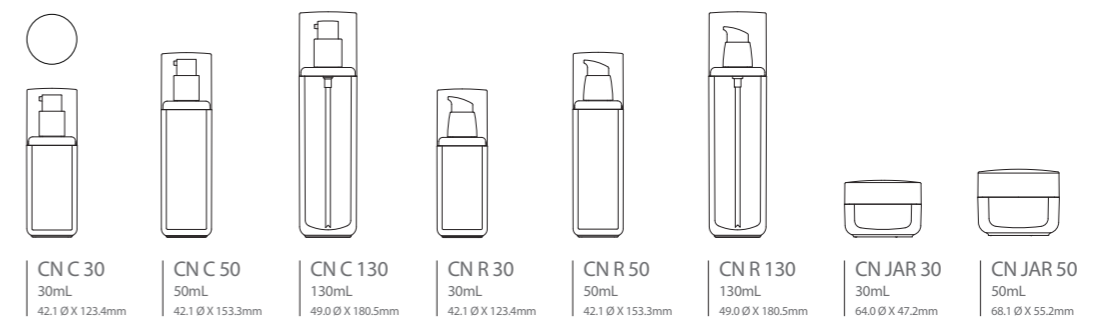

Part Material
• Over Cap : PETG • Actuator : PP • Shoulder : ABS • Inner Bottle : PP • Outer Bottle : PETG

RDA Series

New double wall airless container with simple and fabulous design. Inner bottle can be replaced with refill-bottle easily.

YP Series

Simple look double wall bottles can be combined with diverse shapes of airless pump.



RDA Series



YP Series

Refillable Double Wall Airless

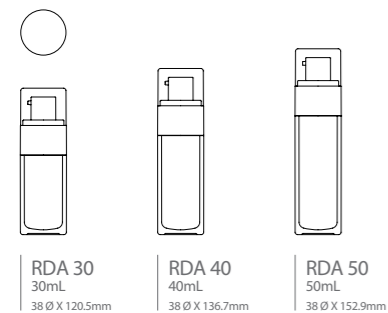

RDA 30
30mL
38 Ø X 120.5mm

RDA 40
40mL
38 Ø X 136.7mm

RDA 50
50mL
38 Ø X 152.9mm

Refillable Inner Bottle

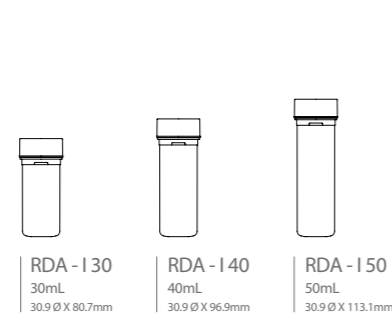

RDA - I 30
30mL
30.9 Ø X 80.7mm

RDA - I 40
40mL
30.9 Ø X 96.9mm

RDA - I 50
50mL
30.9 Ø X 113.1mm

Part Material
• Over Cap : PETG • Actuator Cover : ABS • Shoulder : ABS • Inner Bottle : PP • Outer Bottle : SAN/PETG

YP EL Series

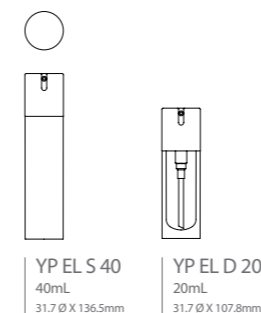

YP EL S 40
40mL
31.7 Ø X 136.5mm

YP EL D 20
20mL
31.7 Ø X 107.8mm

YP R Series



YP R S 40
40mL
31.7 Ø X 139.2mm

YP R D 20
20mL
31.7 Ø X 110.7mm

YP C Series

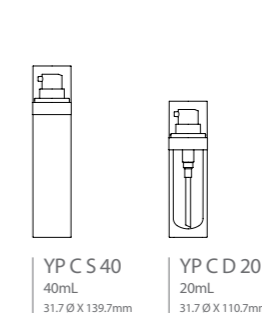

YP C S 40
40mL
31.7 Ø X 139.7mm

YP C D 20
20mL
31.7 Ø X 110.7mm

Part Material
• Over Cap : PETG • Actuator Cover : ABS • Actuator (Inner) : PP • Shoulder : PETG • Single Bottle : SAN/PETG • Inner Bottle : PP • Outer Bottle : SAN / PETG

NB Series

Flush designed double wall structure for both skincare and base-makeup products. Available in airless systems and jars.



NB Series

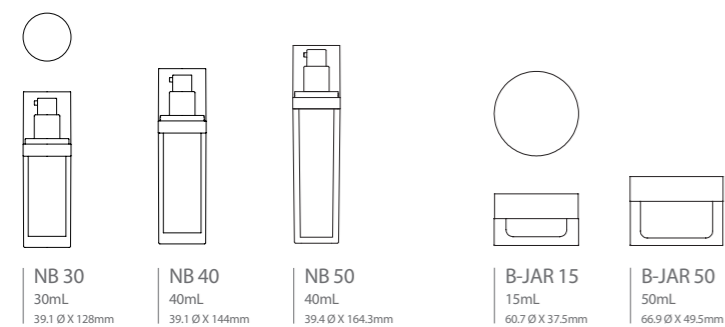

Part Material
• Over Cap : PETG / SAN • Actuator : PP • Shoulder : ABS • Inner Bottle : PP • Outer Bottle : SAN

Various Designs

Various designs of classic type dual structure airless bottle.



Various Desings

YSL Series



Part Material
• Over Cap : PETG/ABS • Actuator : PP • Shoulder : ABS • Inner Bottle : PP • Outer Bottle : SAN/PETG • Base : ABS(YSL)

Basic Square Series

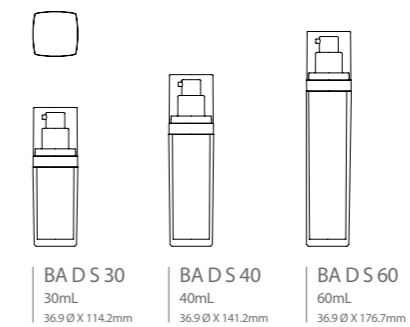

JAR & DROPPER LINE



Airless Jar Series

Multiple purposes airless jars.
Normal palette actuator-one-hole and 12-holes-for skincare products and cushion-inserted actuator for low viscous base make-up products.



Airless Jar Series

Airless Jar Series

4 types of over caps ready for securing concealer or puff.



Airless Jar Series

1-hole palette



12-hole palette



Part Material
• Palette : PP • Shoulder : PETG • Inner Bottle : PP • Outer Bottle : PETG

Cushion palette



Part Material
• Over Cap : PETG • Palette : PP • Shoulder : PETG • Inner Bottle : PP • Outer Bottle : PETG

Overcap

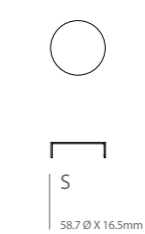

Flip-top cap

mirror + puff mirror + dish (pp)

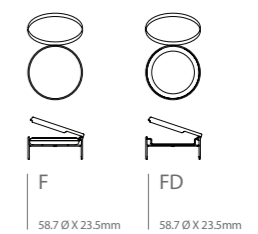

Dropper Series

New droppers using pump engine. It offers soft feel and accurate dosage.



Dropper Series

DR S 15 15mL 27 Ø X 90.3mm	DR S 30 30mL 33.6 Ø X 117.5mm	DR D 10 10mL 27 Ø X 90.3mm	DR D 20 20mL 33.6 Ø X 117.5mm	DR LN 30 30mL 32.2 Ø X 108.9mm	DR LN 40 40mL 32.2 Ø X 125.9mm	DR LN 50 50mL 35.7 Ø X 126.7mm	DR3 B 15 15mL 27.5 Ø X 79.8mm	DR3 B 30 30mL 27.5 Ø X 114.1mm	DR3 M 15 15mL 27.3 Ø X 79.8mm	DR3 M 30 15mL 27.3 Ø X 117.5mm

Part Material
• Dropper Actuator: PP/ABS • Dropper Collar: PP/ABS • Dropper Pipette: PETG • Inner Bottle: PP • Outer Bottle: SAN/PETG

Auto Dropper Series

When the dropper unscrewed, the contents are automatically filled in pipette with rising up of button. Using pump engine, it offers soft feel and accurate dosage.



Auto Dropper Series

ADR S 30 30mL 33.6 Ø X 125.7mm	ADR D 20 20mL 33.6 Ø X 125.7mm	ADR LN 30 30mL 32.2 Ø X 104.5mm	ADR LN 40 40mL 32.2 Ø X 120mm	ADR LN 40 40mL 35.7 Ø X 120.7mm	ADR3 B 15 15mL 27.3 Ø X 79.8mm	ADR3 B 30 30mL 27.3 Ø X 111.8mm	ADR3 M 15 15mL 27.5 Ø X 79.8mm	ADR3 M 30 30mL 27.5 Ø X 114.1mm

Part Material
• Dropper Actuator: PP/ABS • Dropper Collar: PP/ABS • Dropper Pipette: PETG • Inner Bottle: PP • Outer Bottle: SAN/PETG



AIRLESS COMPACT

AC 1 button type

World's first patented airless pump compact for liquid products.
One-hole orifice is shut-off automatically by actuation of button.
Multi-hole orifice system gives even dispensing of formula on palette.



Airless Engine Ver.1

AC 1 multi-hole & two-ring type

Flat top compact with a full size mirror inside.
Two kinds of airless engines for liquid contents available.
Dispensing through 36 tiny holes and dispensing with centric circle can give visual uniqueness.



Airless Engine Ver.1

button / shut-off

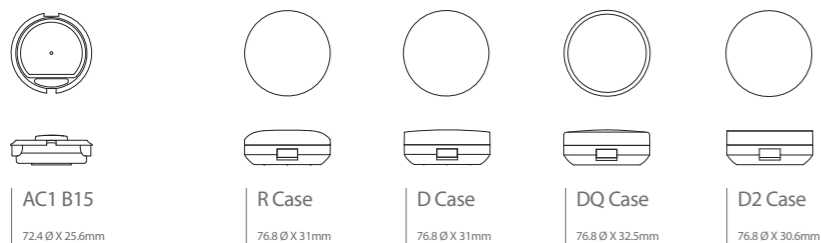

Part Material
• Palette : PP • Platform : ABS • Pump Button : SAN • Case : ABS • Push Button : PC

button / multi-hole & two-ring

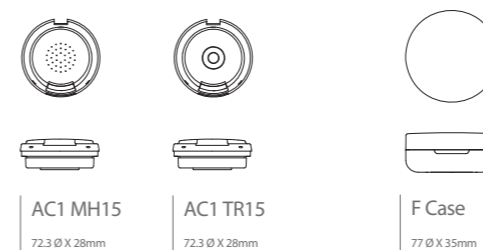

Part Material
• Palette : PP • Pump Button : Actuator • Case : ABS

AC 1 touch type

Simple and easy use by just pushing the palette.
Available in 15ml and 10ml inner bottle with 4 various designs of compact cases.



Airless Engine Ver.1

AC 1 slide type

Unique actuating liquid compact especially for high viscous formula.



Airless Engine Ver.1

touch

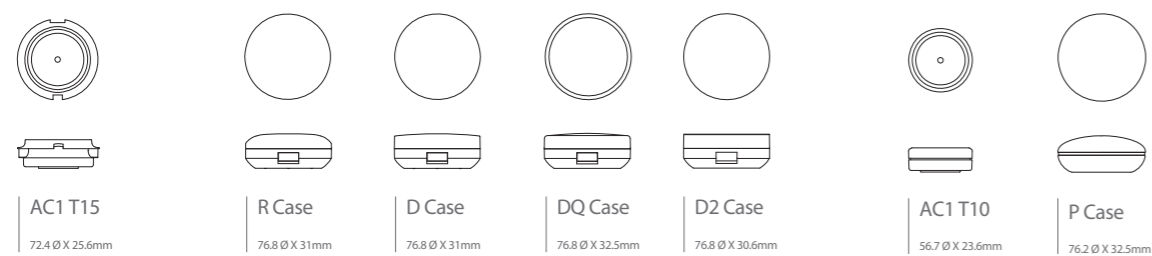

Part Material
• Palette : PP • Platform : ABS • Case : ABS • Push Button : PC

slide / shut-off

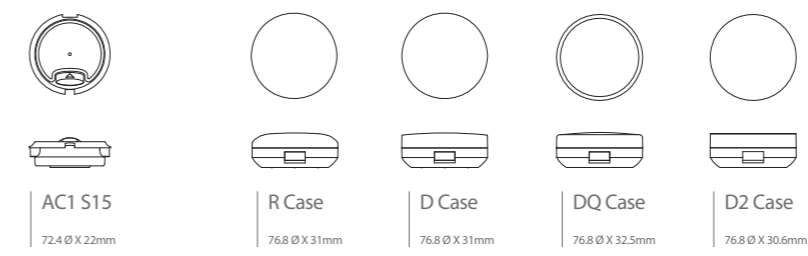

Part Material
• Palette : PP • Case : ABS • Push Button : PC

AC 2 slim type

World's thinnest patented 15ml airless system with full size mirror and puff.
Simple and sleek design with only 25.9mm height.



Airless Engine Ver.2

touch / slim

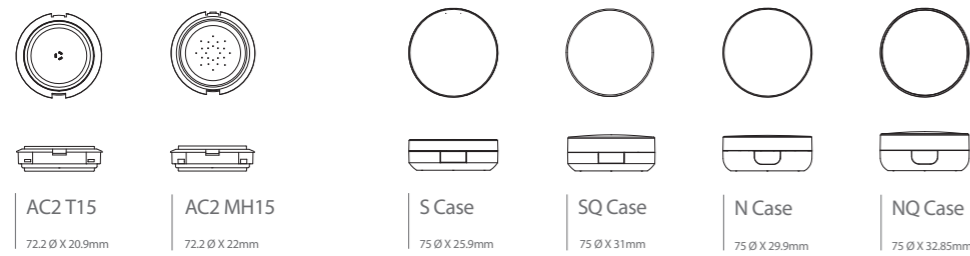

Part Material
• Palette : PP • Platform : ABS • Case : ABS • Push Button : PC

AC 2 cushion type

Ultimate solution for liquid foundation.
Patented structure combining merits of airless system and cushion compact.
Airtight inner lid prevents sponge on the palette from easily drying out.



Airless Engine Ver.2

touch / cushion

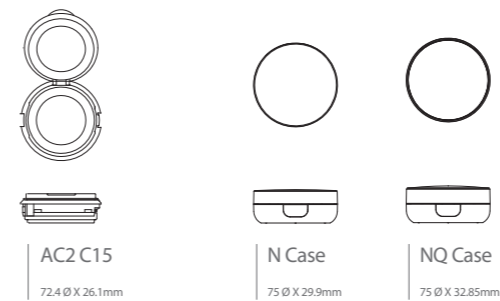

Part Material
• Inner Lid : PP • Palette : Sponge • Case : ABS • Push Button : PC

AC 2 shut-off type

Orifice shut-off automatically by actuation of button.
Perfect for preventing drying and contamination of the formula.



Airless Engine Ver.2

shut-off / one-hole

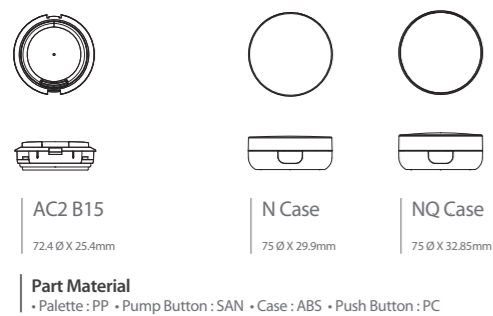

AC 2 hybrid type

Patented dual actuating system by pushing the button and palette.
Formula come out evenly through 16 small orifices for quick and effective conveyance to the puff.



Airless Engine Ver.2

Hybrid / multi-hole

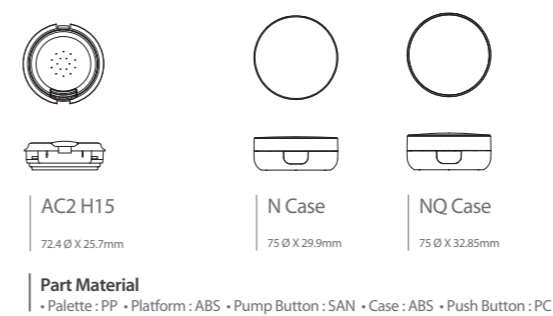

AIRTIGHT COMPACT



AT 1 melting & cushion

Air-tight function by NBR gasket with 4 various designs of compact cases.



Air-Tight Engine Ver.1

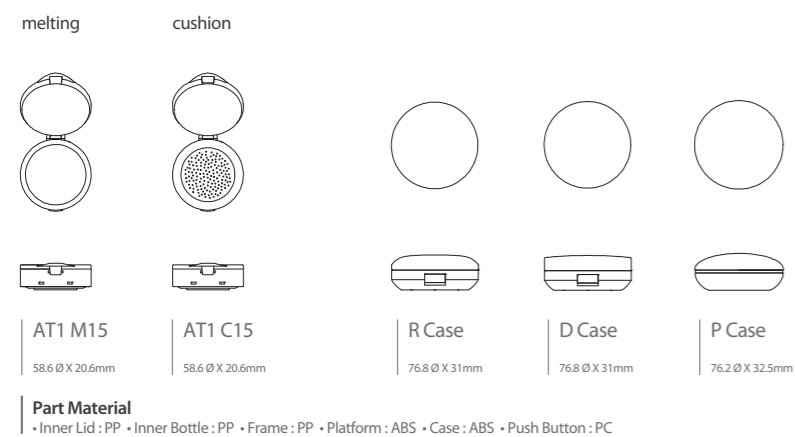

73 Compact melting & cushion

Patented air-tight structure for minimizing weight loss of formula.
Available in 2 different types of basic and simple designed compact case.
(Flat-top type / Dome-shaped plaque type)



Air-Tight Engine Ver.2

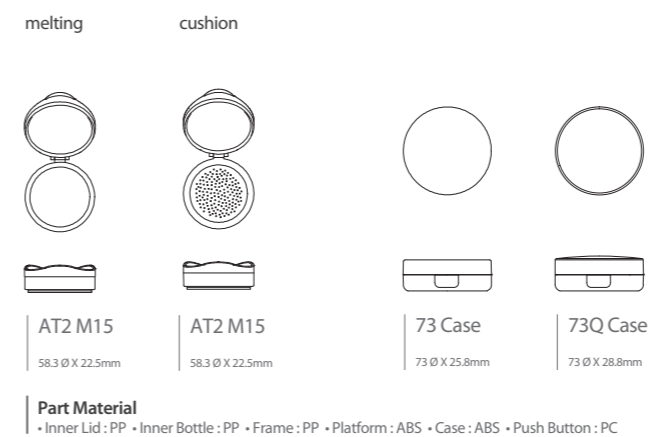

73 Compact membrane

2 types of formula available with patented air-tight function.
Silicone pad for mineral powder / NBR pad for high viscous liquid.



Air-Tight Engine Ver.2

powder high viscosity liquid

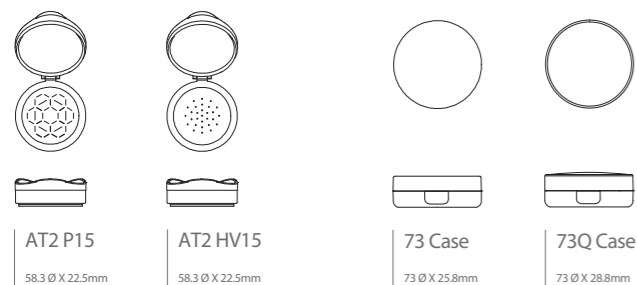

Part Material
• Inner Lid : PP • Inner Bottle : PP • Frame : PP • Platform : ABS • Case : ABS • Push Button : PC

Crayon Compact

2 in 1 set for a cushion compact and a color stick.
A mini crayon-shaped color stick is sliding in and out automatically by opening and shutting the upper case.
Cushion type liquid contents and melting type products are available.



Air-Tight Engine Ver.2

melting cushion powder high viscosity liquid

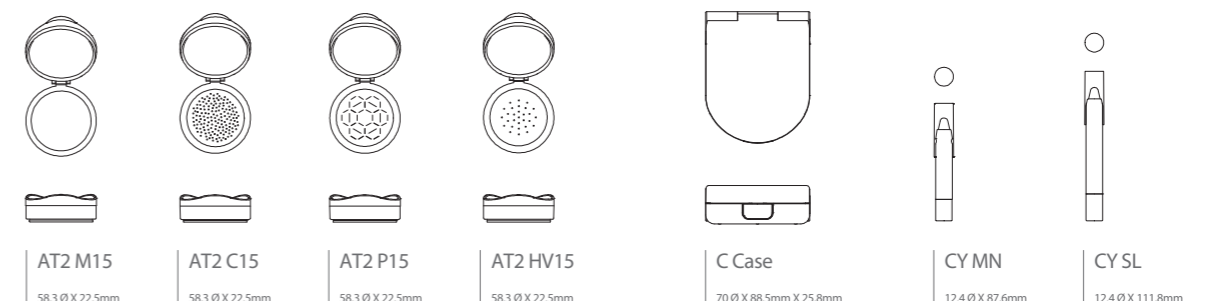

Part Material
• Inner Lid : PP • Inner Bottle : PP • Frame : PP • Platform : ABS • Case : ABS • Push Button : PC • Crayon Over Cap : K-Resin • Crayon Bottle : SAN

G Compact

Two kinds of round-shaped cushion compact.
Mid-size for base make up products and small size for point make up products are available.
The transparent lower case makes this compact more fancy.



Air-Tight Engine Ver.3

Various Compacts

MINI COMPACT : For promotional cushion compact or point make-up compact with air-tight function.
Patented "pin-free" assembly structure.
H PACT : Simple and transparent look compact which is designed for an availability of inside-coating in upper and lower cases.



Various Compacts

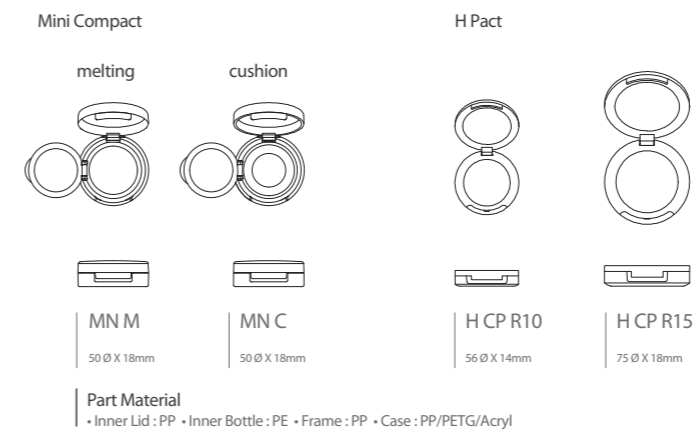
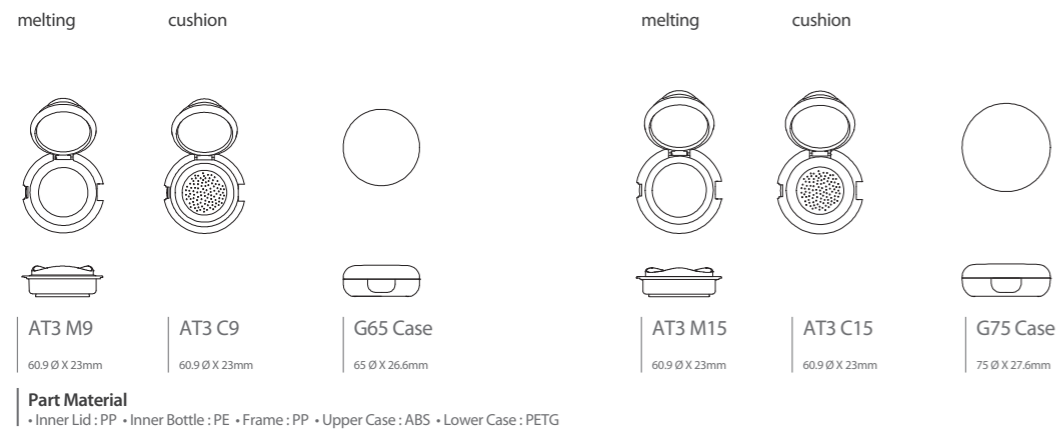



TUBE & POUCH LINE

Pump Tube Series

Most popularized airless system firstly made by Pumtech



Pump Tube Series

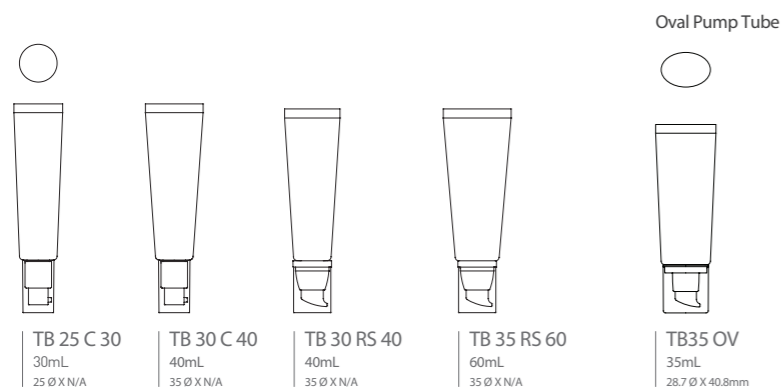

Part Material
 • Over Cap : PETG/ABS/SAN • Actuator : PP • Shoulder : ABS/PP • Tube : PE/Poly-foil

Sponge Tube & Zamac Tip Tube Series

Sponge Tube : 19mm and 30mm tube with soft applicator as a finger-free concept and an orifice is automatically opened and shut by over cap.

Zamac Tip Tube : 19mm and 22mm tube with zamac tip for cooling effect.

The luxurious zamac tip applicator can give cooling massage effect to the skin.
 19mm and 22mm tubes available.



Sponge Tube & Zamac Tip Tube Series

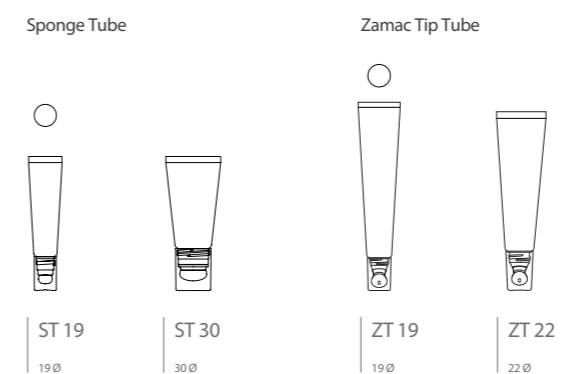

Part Material
 • Over Cap : PP • Shoulder : PP • Tube : PE/Poly-foil

Tube Case Series

New mechanism of airless as tube shape.
As a dual structure, inside tube or inside pouch is shrunk with pumping.
Creative decorations are available.



Case Series

Mouse Series

New mechanism of airless as computer-mouse shape.
As a dual structure, inside aluminum pouch is shrunk with pumping.



Mouse Series

Tube Case Series

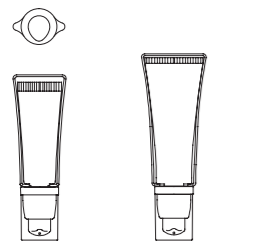

TCRS 20
20mL
31 Ø X 130.7mm

TCRS 40
40mL
34.7 Ø X 147.7mm

Oval Case Series



OVTC 40
40mL
34 X 45 X 162mm

Blow Pouch Case Series

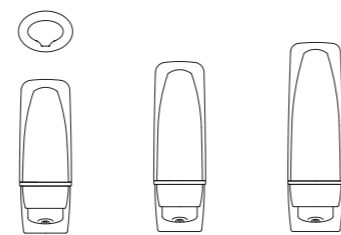

OVBC 30
30mL
33 X 43 X 124mm

OVBC 40
40mL
33 X 43 X 138mm

OVBC 60
60mL
36 X 45 X 154mm

Part Material
• Over Cap : ABS/PETG • Actuator : PP • Shoulder : ABS • Inner Tube : PBL tube / PE blow • Case : PETG/PP

Airless AL Pouch System

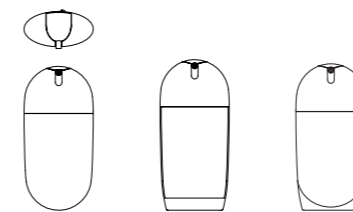

MS 1 A 35
35mL
28.8 X 56.7 X 119.9mm

MS 2 A 40
40mL
28.8 X 56.7 X 123.4mm

MS 3 A 35
35mL
28.8 X 56.7 X 119.9mm

Part Material
• Actuator : PP • Shoulder : ABS • Inner Bottle : AL pouch • Outer Bottle : PETG

DIP Tube Blow Bottle

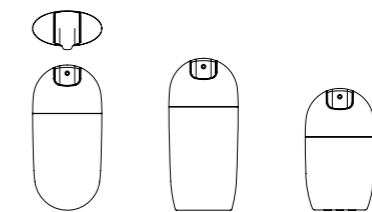

MS 1 B 60
60mL
28.8 X 56.7 X 118.3mm

MS 2 B 70
70mL
28.8 X 56.7 X 123.8mm

MS 3 B 50
50mL
28.8 X 56.7 X 99.5mm

Part Material
• Actuator : PP • Shoulder : ABS • Bottle : Surlyn

VARIOUS DESIGNS



Dual Airless Series

Dual structure airless container.
Two different formulas in the separate inner bottles are pumped out individually.



Dual Airless Series

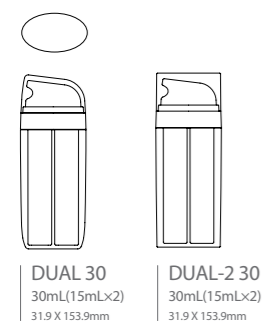

DUAL 30
30mL(15mLx2)
31.9 X 153.9mm

DUAL-2 30
30mL(15mLx2)
31.9 X 153.9mm

Part Material
• Over Cap : PP • Actuator : PP • Shoulder : PP • Inner Bottle : PP • Outer Bottle : PP

Stick Series

Three sizes of dial-screw system can be applied for deodorant and stick-foundation.



Stick Series

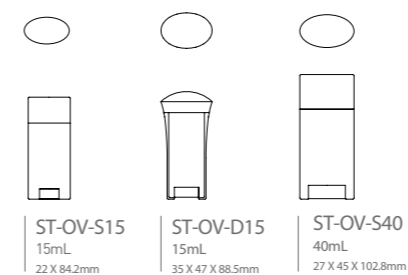

ST-OV-S15
15mL
22 X 84.2mm

ST-OV-D15
15mL
35 X 47 X 88.5mm

ST-OV-S40
40mL
27 X 45 X 102.8mm

Part Material
• Over Cap : PP • Bottle : PP

DISPENSERS



Dispenser

Various shapes and sizes of dispensers for your own customized designs.



18SM-M
18 Ø X 11mm / 0,2cc
overcap



18SM-B
18 Ø X 11mm / 0,2cc
overcap



18SM-H
18 Ø X 11mm / 0,2cc
overcap



18SM-W
18 Ø X 11mm / 0,2cc
overcap



18S-B
18 Ø X 11mm / 0,2cc
overcap



18S-H
18 Ø X 11mm / 0,2cc
overcap



18S-W
18 Ø X 11mm / 0,2cc
overcap



18LM-M
18 Ø X 14,9mm / 0,2cc
overcap



18LM-B
18 Ø X 14,9mm / 0,2cc
overcap



18LM-H
18 Ø X 14,9mm / 0,2cc
overcap



18LM-W
18 Ø X 14,9mm / 0,2cc
overcap



20BM-M
20 Ø X 15,8mm / 0,2 / 0,3cc
overcap



20BM-B
20 Ø X 15,8mm / 0,2 / 0,3cc
overcap



20BM-H
20 Ø X 15,8mm / 0,2 / 0,3cc
overcap



20BM-W
20 Ø X 15,8mm / 0,2 / 0,3cc
overcap



20J-B
20 Ø X 15,5mm / 0,2 / 0,3cc
overcap



20J-H
20 Ø X 15,5mm / 0,2 / 0,3cc
overcap

Dispenser

Various shapes and sizes of dispensers for your own customized designs.



18RS-M-R
18 Ø X 10,5mm / 0,2cc
actuator clip



18RS-R
18 Ø X 10,5mm / 0,2cc
actuator clip



21RM-R
21 Ø X 8,6mm / 0,2 / 0,3cc
actuator clip



21R-R
21 Ø X 8,6mm / 0,2 / 0,3cc
actuator clip



20SM-M
20 Ø X 13,2mm / 0,2 / 0,3cc



20SM-R
20 Ø X 13,2mm / 0,2 / 0,3cc



24JPD-JP
24 Ø X 18,5mm / 0,3cc
overcap



24JPS-JP
24 Ø X 18,5mm / 0,3cc
overcap



24OM-O
24 Ø X 14,2mm / 0,7cc
lock



24O-O
24 Ø X 14,2mm / 0,7cc
lock



24NS-N
24 Ø X 14,2mm / 0,5 / 0,7cc
overcap



24N-N
24 Ø X 14,2mm / 0,5 / 0,7cc
overcap



18OL-R
18 Ø X 16,2mm / 0,2cc
overcap



18V-V
18 Ø X 10,7mm / 0,2cc
overcap



18CS-STA
18 Ø X 10,8mm / 0,15cc
lock



20SM-STAR
20 Ø X 13,4mm / 0,2cc



18RS-STAR
18 Ø X 10,5mm / 0,2cc

* Neck height is not included inside gasket.
With several kinds of gasket heights, above actuators can meet required dimensions.

PUMTECH KOREA CO., LTD.

46, Bupyeong-daero 329-gil, Bupyeong-Gu, Incheon, KOREA

www.pum-tech.co.kr

Tel : 82-32-683-4080 Fax : 82-32-683-4084

Domestic : ptk@pum-tech.co.kr

International : sales@pum-tech.co.kr



Information in this catalogue can be changed without notice.

JAN. 2016