

# Vision Verte

by  FIRPLAST

ÉDITION 2016



Solutions pour la livraison à domicile,  
la vente à emporter et la consommation sur place.

Des idées ...

 **FIRPLAST**  
pour vous « emballer »

**PACK POUR LE FUTUR**

# CONCEPTION, FABRICATION & DISTRIBUTION

## FIRPLAST LYON SERVICE COMMERCIAL

4 rue de Provence · 69800 SAINT PRIEST  
Tél : 04 72 23 66 66 · Fax : 04 78 20 54 40  
Mail : [contact@firplast.com](mailto:contact@firplast.com)  
[www.firplast.com](http://www.firplast.com)

Créé en 1983, Firplast est en mesure de vous proposer un service efficace et adapté grâce à ses structures, ses capacités techniques et ses moyens humains. Nous vous permettons à l'aide d'un franco étudié de gérer au mieux vos flux sans augmenter votre coût de stockage.

- Plus de 100 000 m<sup>3</sup> de surface de stockage.
- Tous les articles présents dans le catalogue sont en stock.
- Procédure rapide de traitement des commandes jour A (par téléphone, fax, mail).
- Expédition des commandes jour B.
- Livraison par nos camions ou messagerie sous 48 à 72 h pour la France métropolitaine et sous 10 jours pour les autres pays européens.

Nous livrons le monde entier, n'hésitez pas à contacter notre responsable export pour toute question : [export@firplast.com](mailto:export@firplast.com)

Nos autres missions :

- Solutions durables et respectueuses de l'environnement pour particuliers et professionnels : [contact@vision-verte.com](mailto:contact@vision-verte.com)
- Conditionnement adapté aux particuliers et à la grande distribution : [contact@mes-verrines.com](mailto:contact@mes-verrines.com)
- Décoration à thème, animation, et déguisements : [contact@axho.com](mailto:contact@axho.com)
- Liaison froide et collectivités : [collectivite@firplast.com](mailto:collectivite@firplast.com)
- Solutions transport : [nomade@firplast.com](mailto:nomade@firplast.com)

N'hésitez pas à vous rendre sur nos sites internet ou nous contacter. Notre service commercial prendra contact avec vous dans les meilleurs délais.

Découvrez tout notre univers sur nos sites et retrouvez la version PDF de nos catalogues sur : [www.firplast.com/catalogues](http://www.firplast.com/catalogues)

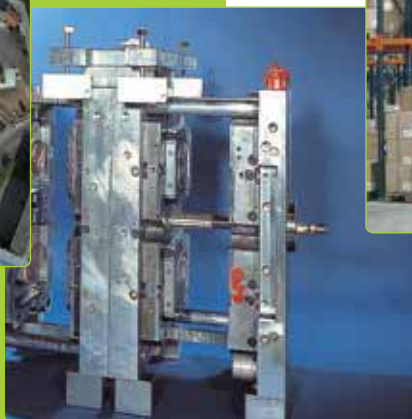

# NOTRE RÉSEAU

Hacemos envíos a cualquier lugar del mundo. Si desea realizar alguna consulta, no dude en ponerse en contacto con nuestro departamento de exportaciones: [export@firplast.com](mailto:export@firplast.com)

Otros departamentos:

- Soluciones sostenibles y respetuosas con el medioambiente para particulares y profesionales : [contact@vision-verte.com](mailto:contact@vision-verte.com)
- Embalajes para particulares y grandes empresas de distribución : [contact@mes-verrines.com](mailto:contact@mes-verrines.com)
- Decoración temática, actividades y disfraces : [contact@axho.com](mailto:contact@axho.com)
- Línea fría y colectividades : [collectivite@firplast.com](mailto:collectivite@firplast.com)
- Soluciones de transporte : [nomade@firplast.com](mailto:nomade@firplast.com)

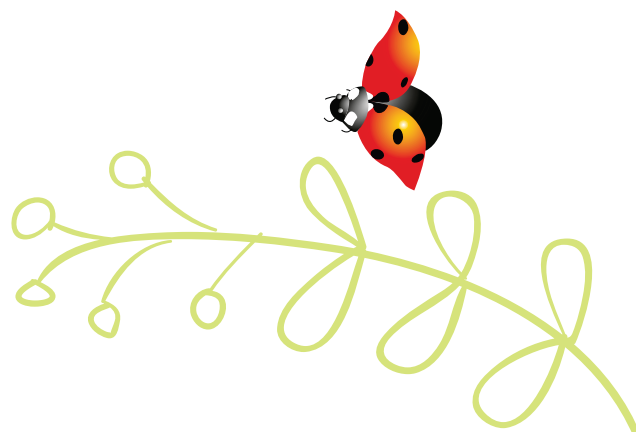

No dude en visitar nuestras páginas web o en ponerse en contacto con nosotros. Nuestro departamento de ventas se pondrá en contacto con usted lo antes posible. Consulte todos nuestros productos en nuestras páginas web y la versión PDF de nuestro catálogo en : [www.firplast.com/catalogues](http://www.firplast.com/catalogues)



[www.firplast.com](http://www.firplast.com)



[www.mes-verrines.com](http://www.mes-verrines.com)

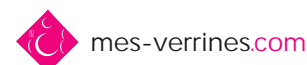

[www.vision-verte.com](http://www.vision-verte.com)



[www.vaisselle-eugenie.com](http://www.vaisselle-eugenie.com)



LA VAISSELLE  
D'EUGÉNIE

[www.axho.com](http://www.axho.com)



# SOMMAIRE



CONCEPTS DE RESTAURATION / CONCEPTOS DE RESTAURACIÓN .....P.16-29

CONCEPT SANDWICH.....P.17

SANDWICHERIE CHAUDE .....P.18

SANDWICHERIE FROIDE .....P.19

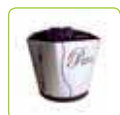

SALAD BAR.....P.20-23

BURGER .....P.24

FRITERIE.....P.25

FINGER FOOD .....P.26

PIZZERIA .....P.27

POULET .....P.28

SOUP BAR .....P.29



BARQUETTES, COQUILLES ET MINI POTS / BANDEJAS Y TARRINAS .....P.30-33

COQUILLES .....P.31

MINI-POTS .....P.32

BARQUETTES .....P.33

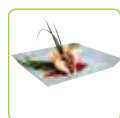

ASSIETTES / PLATOS.....P.34-37

DESSERTS / POSTRES .....P.38-40



GLACES .....P.39

PÂTISSERIES .....P.40



COUVERTS / CUBIERTOS .....P.41-45

COUVERTS INDIVIDUELS.....P.42

ACCESSOIRES.....P.43-44

SACHETS COUVERTS .....P.45



LIQUIDES / VASOS .....P.46-51

BOISSONS FROIDES.....P.47

BOISSONS CHAUDES.....P.48-51



# SOMMAIRE



ÉVÈNEMENTIEL / CRONOLÓGICO .....P.52-55



SACHERIE ET TRANSPORT / BOLSAS Y TRANSPORTE.....P.56

L'OXO BIO .....P.57

LE TISSÉ RÉUTILISABLE .....P.57

LE PAPIER .....P.58-59

LE TRANSPORT .....P.60-61



MISES EN BOUCHE / VASITOS .....P.62-65

COLLECTION «VISION VERTE».....P.63

COLLECTION «WOOD MOOD».....P.63-65



PLATEAUX REPAS ET PLATEAUX / BANDEJAS .....P.66-70

PLATEAUX REPAS.....P.67-70

PLATEAUX .....P.70

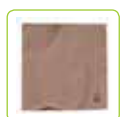

ART DE LA TABLE / ARTE DE LA MESA.....P.71-78

SERVIETTES ET NAPPES COLORÉES.....P.72-78



MATÉRIEL ET HYGIÈNE / MATERIAL Y HIGIENE.....P.79-82

CONDITIONNEMENT ET MATÉRIEL .....P.80-82



BOULANGERIE / PANADERIA.....P.83-85

VIENNOISERIE.....P.84

PAPIERS ET CARRÉS CARTON.....P.85



# NORMES ISO 9001 ET ISO 14001



Attention, ce catalogue ne présente pas QUE des emballages biodégradables. Sa vocation est de proposer des solutions alternatives les plus respectueuses possible de l'environnement tout en conservant les propriétés nécessaires des emballages quant à la conservation des aliments.

## NORME QUALITÉ

Le développement de Firplast repose sur sa capacité à s'adapter en permanence aux évolutions des exigences clients, tout en satisfaisant celles de son personnel, de ses actionnaires et de la réglementation. C'est pourquoi nous avons décidé de mettre en place un système de management de la qualité conforme à la norme ISO 9001 V2008. La stratégie qualité de Firplast est portée à la connaissance de tous les membres du personnel et sera mise en œuvre par chacun.

Pour en garantir la réussite, la direction a choisi de mettre en œuvre cette stratégie qualité qui se décline selon les axes suivants :

- Augmenter la satisfaction de nos clients
- Maîtriser les coûts en utilisant les outils d'amélioration continue.
- Adapter notre offre produit en fonction des attentes du marché.

Les objectifs déclinants de ces axes sont :

- Livrer le bon produit, au bon moment, au bon endroit et au bon prix
- Prévoir ce que l'on doit faire, faire ce que l'on a prévu, vérifier l'atteinte des résultats et réagir efficacement et durablement
- Proposer le bon produit au bon moment et au bon prix

C'est en suivant cette stratégie tous ensemble que nous arriverons à assurer la pérennité et le développement de Firplast dans les années à venir. Soyons convaincus que nos employés, nos clients, nos fournisseurs et autres partenaires sont au cœur de notre succès et que nous devons donc travailler chaque jour à leur satisfaction.

## POLITIQUE ENVIRONNEMENTALE

Aujourd'hui tout le monde s'accorde à dire que non seulement les enjeux environnementaux sont bien réels, mais que les entreprises ont un rôle important pour ne pas dire essentiel à jouer dans la préservation des trois équilibres : l'économique, le social et l'environnemental. Depuis toujours Firplast s'inscrit dans cette démarche. Nous confortons aujourd'hui cette volonté via la mise en place d'un système de management environnemental conforme à la norme ISO 14001.

La direction et les collaborateurs s'engagent :

- à l'amélioration continue des performances environnementales ;
- à la prévention des pollutions ;
- à la conformité aux exigences réglementaires et légales.

Notre engagement se traduit concrètement par l'identification, la maîtrise des risques et le développement progressif des procédures dans les situations d'urgence. Nous mettons en place suite à cette analyse environnementale, des indicateurs et des objectifs qui sont suivis et analysés régulièrement.

Nous nous attachons notamment à minimiser nos impacts environnementaux à l'aide des leviers suivants :

- réduction, recyclage et tri des déchets ;
- réduction de nos consommations énergétiques ;
- réduction de notre consommation de ressources naturelles ;

En tant que directeur de la société, je m'engage :

- à la mise en œuvre de cette politique ;
- à ce qu'elle soit connue, comprise et partagée par tout le personnel de l'entreprise et qu'elle devienne une préoccupation constante dans leur cadre professionnel ;
- à ce que notre politique soit disponible pour le public et communiquée à toute personne travaillant pour notre compte.

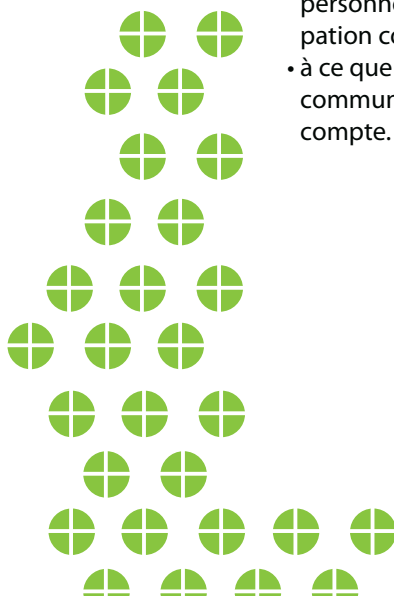

# LÉGENDE

## MATIÈRES



Pulpe de canne à sucre



Produit compostable conforme à la norme EN 13432



Produit non conforme à la norme EN 13432



PLA : Amidon de maïs



CPLA : Amidon de maïs



Bois



Carton et Pure pâte avec protection de surface en cellulose



Papier



PS : Polystyrène



PP : Polypropylène



PET : Polyéthylène

## RÉSISTANCE



Froid



Convient aux produits réchauffés



Résiste au four traditionnel (150°C Maxi pour la Pulpe)



Micro-ondable



Ne résiste pas au four traditionnel



Non micro-ondable

## PERSONNALISATION



Produit personnalisable

## ACHAT



Produit sur commande



Produit sur pré-commande

## CARACTÉRISTIQUES TECHNIQUES

 **DIMENSIONS**  
DIMENSIONS

 **CAPACITÉ**  
CAPACITY

 **RÉFÉRENCE**  
REFERENCE

 **CONDITIONNEMENT**  
PACKAGING

# NOS GAMMES DE PRODUITS



Les matières biodégradables :  
PLA, Pulpe, Bois, Carton.

Vers un plastique sans pétrole ...  
LES BIOPLASTIQUES : Ils sont fabriqués à partir de biopolymères issus de ressources renouvelables, végétales comme la cellulose ou l'amidon. On peut également les produire à partir de protéines (la caséine de lait ou encore le gluten) mais aussi de bactéries grâce au génie génétique. L'un des biopolymère le plus utilisé aujourd'hui pour l'emballage alimentaire est le polyacide lactique (PLA).

Biodégradable et compostable.  
Sous des conditions normales de climat chaud et humide, notre produit se dégradera en quelques mois.

Fibre de canne à sucre

S'il est déposé dans la nature, la bio-dégradation du produit ne causera aucune pollution.

La canne à sucre est une source d'approvisionnement solide, rapide et illimitée.







## LE PLA

# 01

L'acide polylactique est un produit intermédiaire résultant de la fermentation du sucre ou de l'amidon (par exemple de betterave ou de maïs) : les bactéries de l'acide lactique font fermenter le produit de base. Ensuite, l'acide lactique est polymérisé par un nouveau procédé de fermentation, pour devenir de l'acide polylactique (PLA).

On obtient ainsi un plastique blanc, de couleur ou parfaitement transparent, fabriqué de 100% de matière première naturelle. La matière première est transparente et imprimable mais ne résiste pas à la chaleur (-20 à +40°C). On l'utilise essentiellement pour des gobelets, des saladiers mais aussi des couverts très résistants. Son inconvénient pour l'instant : 25 à 30 % plus cher.



### BILAN VERT :

Compostable  
Biodégradable  
Incinérable

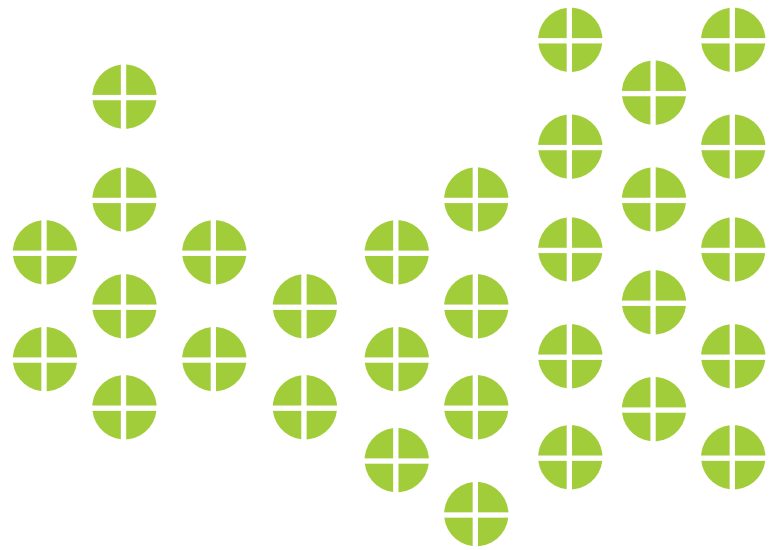

## LE CPLA



Le CPLA (amidon de maïs) est un matériau entièrement biodégradable et résistant jusqu'à 80°C. Son aspect et son touché est très semblable à celui du plastiques. Il est plus agréable à utilisé que le bois.

Notre gamme jetable 100% compostable peut être mise dans un compost et ainsi se dégrader naturellement sans polluer notre environnement.

La matière composant ces couverts répond à la norme européenne de compostabilité EN 13432





## LA PULPE

La pulpe est un matériau issu du résidu fibreux de la canne à sucre après l'extraction du sucre (la bagasse).

Après extraction de la moelle sucrée de la canne à sucre, il reste un résidu fibreux organique qui est généralement brûlé ou jeté.

Mais ces fibres peuvent aussi être traitées pour servir à fabriquer les produits en biofibre. Une seule tige de canne à sucre permet ainsi de fabriquer environ une cinquantaine d'assiettes à usage unique. Les résidus de pressoir résultant de la production d'huile de palme sont souvent utilisés dans le même but.

On obtient un matériau aux multiples propriétés :

- Résistant à l'eau et à l'huile à 100°C
- Micro-ondable jusqu'à 220°C.

### • Scellable

Son aspect est généralement proche du blanc crème mais il peut-être personnalisable. On fabrique en pulpe des gobelets (boisson chaudes ou froides), des barquettes, des plateaux, des assiettes.

## IMPACT ÉCONOMIQUE

Cycle de la création de la ressource du produit à sa fin de vie.

### 1/ Création :

Matière première quasi gratuite, consommation d'eau marginale.

### 2/ Production :

Consommation d'énergie non renouvelable en production en moyenne inférieure de 30% par rapport à des plastiques.

### 3/ Distribution :

- Coût du transport qui représente environ 15% de la valeur du produit fini jusqu'au lieu de distribution.
- Surcoût pour l'utilisateur relativement faible (environ 10% par rapport à du PSE).
- Nombreuses utilisations en chaud et froid...
- Personnalisation pas toujours évidente.

# 02

## IMPACT SUR L'ENVIRONNEMENT

- Production agricole : la canne à sucre, plante qui nécessite moins d'eau que le maïs.
- La pulpe est issue d'une ressource totalement renouvelable plusieurs fois par an.
- Le but d'un matériau biodégradable est de disparaître en fin de vie du produit, ce qui est le cas de la pulpe.
- La vaisselle est fabriquée à partir des résidus de la canne à sucre.
- Emballage non polluant
- Biodégradable : le produit se décompose naturellement pour retrouver sa forme première de fibre de cellulose totalement assimilable par le milieu dont elles proviennent.
- Bilan carbone pour un emballage d'un litre moins de 80 g de Co<sup>2</sup> contre 129 g pour un emballage équivalent en pet et 345 g pour du verre.
- Produit plus léger donc moins d'énergie non renouvelable consommée.
- Lieu de production éloigné dans notre cas.

En résumé le bilan des indicateurs environnementaux tel que le réchauffement climatique, la consommation d'énergie non renouvelable, l'acidification de l'air, l'utilisation d'eau plaide en faveur de la pulpe de canne à sucre.



### BILAN VERT :

Compostable  
Biodégradable  
Incinérable



# 03

## LE BOIS



En peuplier laminé par exemple, mais toujours issu de forêt gérée pour un développement durable et recouvert d'une couche de cire biodégradable pour que les pièces ne partent pas en fibres.

Le Ramie est le résultat du mélange de différentes plantes d'Asie tropicale telle que la canne à sucre et les fibres de jonc.

Résistante à l'eau et à la chaleur, il supporte la cuisson au micro-ondes. On l'utilise pour la fabrication d'assiettes et de bols. Il est utilisé pour les plats chauds ou froids.

C'est un produit naturel par essence. Il permet de multiples applications : assiettes, plateaux, couverts, barquettes rectangulaires et rondes, pique-bois, agitateur, baguettes...

### BILAN VERT :

Compostable  
Biodégradable  
Incinérable

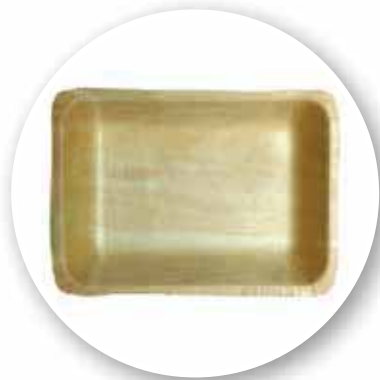

## LE CARTON

# 04

La Cellulose est une matière première obtenue à partir de bois et transformée en papier ou carton.

Pas vraiment nouveau sur le marché de la vaisselle à usage court et l'emballage alimentaire, FIRPLAST vous propose une sélection exclusive de produits issus du bois et de papier recyclé, en présentant un aspect très qualitatif toujours accompagné du logo «Recyclable».

Vous trouverez une large sélection d'emballages pour pâtisseries, chaînes de pizza, des gobelets pour le chaud et le froid, des saladiers, des pots à soupe, des «cups» à pasta, des barquettes, des assiettes...

Le carton est recyclé à 70 %.

### BILAN VERT :

Compostable  
Biodégradable  
Incinérable



## LE CARTON AVEC PROTECTION DE SURFACE EN CELLULOSE



Le carton en pure pâte avec protection de surface en cellulose est obtenue sans aucune extrusion ou couchage de film plastique. Il est réalisé à partir de matières premières renouvelables, issues de forêts écogérées.

Il supporte le passage de la surgélation (-40°C) au four traditionnel (175°C pendant une heure) ainsi qu'au micro-onde. Résistant aux graisses et à l'humidité, il est apte au contact alimentaire selon les directives CE 1935/2004, CE 75/2005 et EU Reg 10/2011.

**BILAN VERT :**  
Compostable  
Biodégradable  
Recyclable



Pensez l'avenir dès aujourd'hui !

# PULPE IS AMAZING

Extrêmement robustes et résistants à l'eau, à l'huile et au froid, les produits de vaisselle en pulpe sont micro-ondables (jusqu'à 220°C), scellables et sont parfaitement adaptés à la congélation.

Assiettes, plateaux, gobelets, barquettes, bols et pots... découvrez tous nos produits en pulpe !



Mini-pot



Assiettes



Desserts



Tous nos produits de la gamme pulpe ont le label écologique OK compost.  
Tout emballage ou produit muni du label OK COM-POST est garanti biodégradable et compostable en installation industrielle de compostage. Ceci s'applique à tous les composants, encres et additifs : le produit se désintègre complètement sans effets nuisibles pour la qualité du compost.



Saladerie



Verrine



Gobelet



Couverts



Barquettes



Plateau repas





Saladerie



Burger



Sandwicherie



Boulangerie



**KRAFT IS BEAUTIFUL**





Napperie



Gobelets

Friterie



Finger food

Sacherie



Découvrez notre gamme d'emballage en kraft brun, idéale pour les professionnels de la restauration rapide, snack, vente à emporter et boulangerie. Une gamme naturelle, authentique et recyclable. Pour présenter ou emballer vos produits, nous vous proposons un large choix de boîtes hamburger kraft, boîtes sandwich, gobelets, sacs cabas, saladiers, sacs croissants...



# CONCEPTS DE RESTAURATION

Vous avez un concept, nous vous l'emballons !

La gamme nomade répond aux exigences de praticité et de présentation de tous les métiers de la restauration à thème, de la restauration rapide, de la vente à emporter et de la livraison à domicile.







## LES WRAPS

### ETUI A WRAPS EXTERIEUR KRAFT BRUN, INTERIEUR BLANC

POTE A WRAPS KRAFT MARRON INTERIOR BLANCO

225 x 85 mm  
333150  
750 (15x50)



Ouverture pratique

Facile à transporter

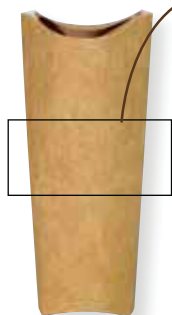

C'est déjà prêt à manger !

PERSONNALISATION - mini : 50 000 pièces

### POT A WRAPS BLANC 5,5 OZ

POTE A WRAPS BLANCO 5,5 OZ

3333010  
1200



### POT A WRAPS KRAFT BRUN 5,5 OZ

POTE A WRAPS MARRON 5,5 OZ

3333010KR  
1200 (24x50)



### BOÎTE WRAPS AVEC FENÊTRE

KRAFT BRUN

150 x 95 x 53 mm  
3130150  
300 (6x50)



## LES CLUBS

### TRIANGLE SIMPLE BROWN + FENETRE

TRIÁNGULO BOCADILLO MARRON + VENTANA

123 x 52 x 123 mm  
ST2/W1  
500



### TRIANGLE DOUBLE BROWN + FENETRE

TRIÁNGULO BOCADILLO MARRON + VENTANA

123 x 72 x 123 mm  
333125  
500



Emmenez-nous partout !  
Tous nos sacs cabas p.105

Votre logo ici





# SANDWICHERIE CHAUDE

Halte aux tâches avec les ingraissables

## LES CHAUDS ET FROIDS

### SAC SANDWICH KRAFT BLANC PPT



BOLSA SÁNDWICH KRAFT BLANCA PPT

 110 + 40 x 310 mm  
 720017C  
 1000



### SAC SANDWICH KRAFT BRUN PPT



BOLSA SÁNDWICH KRAFT BLANCA PPT

 100 + 40 x 310 mm  
 720017KA  
 1000



### FOND CARTON SANDWICH KRAFT BRUN AVEC PAPIER INGRAISSABLE



FONDO CARTÓN EMPAREDADO KRAFT MORENO  
CON PAPEL INGRAISSABLE

 255x90x40 mm  
 732255  
 1000 (50x20)



### SAC PAPIER HOT DOG INGRAISSABLE



BOLSA PAPEL FRANFURT

 210 x 120 mm  
 SAHOT170/C  
 1000



### SAC SANDWICH BLANC PPT



BOLSA SÁNDWICH BLANCA RESISTENTE A LAS GRASAS

 110 + 55 x 310 mm  
 720017  
 1000



### SAC SANDWICH CRISTAL INGRAISSABLE



BOLSA SÁNDWICH CRISTAL

 10 + 40 x 300 mm  
 73111030  
 1000



### SAC PAPIER CHURROS

BOLSA PAPEL CHURROS



 180 + 60 x 310 mm  
 73243CHURROS  
 1000



## LES DÉCORS ALIZÉ

### SAC PANINI CHAUD DÉCOR ALIZÉ JAUNE



BOLSA PANINI CALIENTE DECORACIÓN "ALIZE" AMARILLA

 100 + 40 x 260 mm  
 73241  
 2000 (2x1000)



### SAC SANDWICH AMERICAIN DÉCOR ALIZÉ BLEU

BOLSA SÁNDWICH AMERICANO DECORACIÓN  
"ALIZE" AZUL

 140 + 60 x 270 mm  
 73242/C  
 1000



Retrouvez toutes nos coquilles p.48



### PERSONNALISATION

1-2 couleurs à partir de 25000 pièces  
3 couleurs - 50 000 formats  
4 couleurs avec aplat total 100 000 formats



# SANDWICHERIE FROIDE



## LES DÉCORS ALIZÉ

### SAC SANDWICH KRAFT BLANC DÉCOR ALIZÉ

*SACO BOCADILLO KRAFT BLANCO DECORADO ALISIO*

 110 + 40 x 310 mm

 703241/C

 1000



### SAC SANDWICH ALIZE BLEU

*BOLSA SANDWICH ADORNO ALIZE AZUL*

 100 + 50 x 360 mm

 73243/C

 500



## LES SACS BAGNATS

### SAC SANDWICH BAGNAT KRAFT BRUN

*BOLSA SÁNDWICH REDONDO*

 160 x 160 mm

 76131

 1000



### SAC SANDWICH BAGNAT BLANC

*BOLSA SÁNDWICH REDONDO BLANCA*

 200 x 210 mm

 10HBP3

 1000



### PERSONNALISATION

1-2 couleurs à partir de 25000 pièces

3 couleurs - 50 000 formats

4 couleurs avec aplat total 100 000 formats

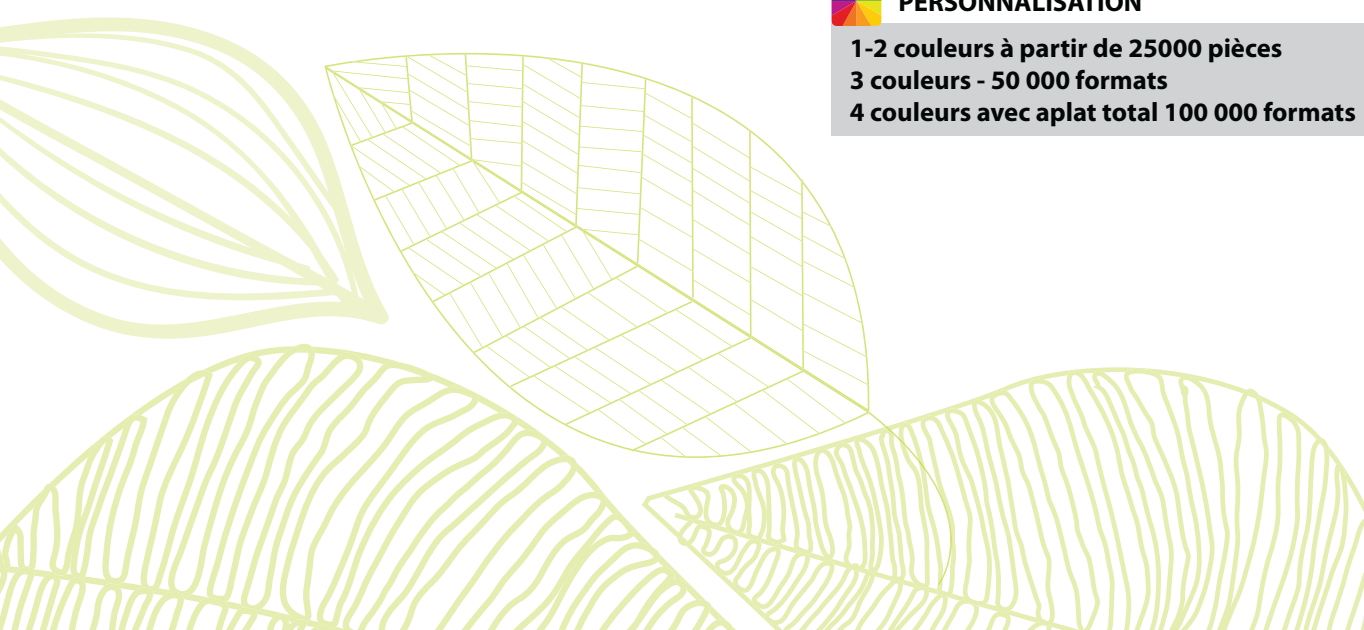

# SALAD BAR

Osez la diversité : saladiers en PLA, carton ou pulpe.

Dans un monde où tout bouge, manger sain devient une priorité au quotidien. FIRPLAST développe toute une gamme de saladiers pour répondre aux besoins de chacun. Vente à emporter libre-service, traiteur ou livraison, laissez-vous guider...



## TOUTE NOTRE GAMME CARTON KRAFT BRUN AVEC FENÊTRE



### BOÎTE CARTON BRUN AVEC COUVERCLE

ENSALADERA KRAFT MORENO CON TAPA

- 220 cc
- 650 x 650 x 400 mm
- 120074
- 300 (12x25)



### BOÎTE CARTON BRUN AVEC COUVERCLE

ENSALADERA KRAFT MORENO CON TAPA

- 420 cc
- 95 x 95 x 40 mm
- 120075
- 300 (12x25)



### SALADIER «UNI BROWN»

ENSALADERA KRAFT MORENO «VIZU BROWN»

- 800 cc
- 150 x 135 x 55 mm
- 3120800PPT2
- 100



### SALADIER «UNI BROWN» KRAFT BRUN

ENSALADERA KRAFT MORENO CON TAPA «UNI BROWN»

- 1000 cc
- 130 x 130 x 50 mm
- 120080/C
- 300 (12x25)

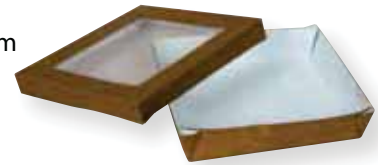

### SALADIER «VIZU BROWN»

ENSALADERA KRAFT MORENO «VIZU BROWN»

- 600 cc
- 140 x 140 x 50 mm
- 3120600KR
- 500 (5x100)



### SALADIER «VIZU BROWN»

ENSALADERA KRAFT MORENO «VIZU BROWN»

- 900 cc
- 31201000KR/C
- 157x160x53 mm
- 500



### SALADIER «VIZU BROWN»

ENSALADERA KRAFT MORENO «UNI BROWN»

- 1200 cc
- 190 x 190 x 50 mm
- 31201200KR
- 320 (8x40)



### SALADIER «UNI BROWN» KRAFT BRUN

ENSALADERA KRAFT MORENO CON TAPA «UNI BROWN»

- 3000 cc
- 240 x 240 x 50 mm
- 120084
- 100 (4x25)



# SALAD BAR

Demain se pense aujourd'hui





## NOTRE GAMME «PULPY MOODY»



**BOL «PULPY BALL» 300 ML**  
TAZON «PULPY BALL» 300 ML





 300 ml  
 145130/C  
 1800 (25x72)



**BOL «PULPY RONDY»**  
CUENCO «PULPY RONDY»





 680 ml  
 145168/C  
 500 (20x25)



**COUVERCLE APET TRANSPARENT**  
TAPA







 145168COV  
 500 (10x50)



**SALADIER «PULPY RUGBY»**  
ENSALADERA «PULPY RUGBY»



 700 ml  
 18,6 x 14,3 x 8 cm  
 14511500  
 500 (20x25)





 1000 ml  
 -  
 145111000  
 500 (8x25)





**COUVERCLE APET TRANSPARENT**  
TAPA



 14511500COV  
 500 (20x25)

**BOL «PULPY SQUARE»**  
CUENCO «PULPY SQUARE»





 250 ml/15 oz  
 145115  
 300 (12x25)



**COUVERCLE PET TRANSPARENT**  
TAPA





 145115COV  
 300 (6x50)



**ASSIETTE «PULPY LINY»**  
PLATO «PULPY LINY»





 130x260 mm  
 115211326  
 300 (12x25)



**COUVERCLE PET TRANSPARENT**  
TAPA





 145x275 mm  
 115211326COV  
 300 (6x50)



**MINI POT EN «PULPY MINI» 57 ML**  
MINIBOTE PULPA



 57 ml - 2oz  
 145105  
 2000 (80x25)



# SALAD BAR

Positionnez-vous «Éco-responsable»





## NOTRE GAMME PLA



### SALADIER ROND PLA 24 CL - 8 OZ



ENSALADERA REDONDA PLA

-  24 cl - 8 oz
-  BIO146008/C
-  500



### COUVERCLE PLA



ENSALADERA REDONDA PLA

-  Ø 102 mm
-  BIO10146000COV
-  500 (10x50)



### SALADIER ROND PLA 30 CL - 12 OZ



ENSALADERA REDONDA PLA

-  30 cl - 12 oz
-  BIO146012/C
-  500 (10x50)



### SALADIER ROND PLA 40 CL - 16 OZ



ENSALADERA REDONDA PLA

-  40 cl - 16 oz
-  BIO146016/C
-  500 (10x50)



### SALADIER ROND PLA 60 CL - 24 OZ



ENSALADERA REDONDA PLA

-  60 cl - 24 oz
-  BIO146024/C
-  500 (10x50)



### COUVERCLE PLA POUR POTS ROUNDS PLA 12/16/24 OZ



TAPA PLA PARA BOTES REDONDOS PLA

-  Ø 102 mm
-  BIO146000COV
-  500 (10x50)





### MINI-POT «CRISTAL» PLA

MINIBOTE «CRISTAL»

-  60 ml
-  BIO1360
-  2000(20x100)





-  80 ml
-  BIO1380
-  2000(20x100)



### COUVERCLE PLA

TAPA

-  -
-  BIO13COV
-  2000 (20x100)



# BURGER

Gagnez du temps, boîtes pré-montées

## LES PRÉ-MONTÉES



### COQUILLE PULPE HAMBURGER

BANDEJA PULPA PARA HAMBURGUESA



140 x 140 x 58 mm  
145140/C  
1000 (40x25)

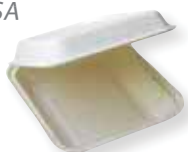

### PLATEAU FAST FOOD ECOLOGIQUE

(MATÉRIAUX RECYCLÉS) / BANDEJA ECOLOGICA  
FAST FOOD (MATERIALES RECICLADOS)

375 x 265 mm  
11PLBIO  
25



### BOITE SIMPLE BURGER KRAFT BRUN MICRO CANNELE / CAJA HAMBURGUESA EN CARTÓN KRAFT MICRO CANELADA

97 x 97 x 61 mm  
334100/C  
720



### BOITE DOUBLE BURGER KRAFT BRUN MICRO CANNELE / CAJA HAMBURGUESA EN CARTÓN KRAFT MICRO CANELADA

110 x 104 x 75 mm  
334110  
600



### BOITE BURGER GÉANT KRAFT BRUN MICRO CANNELE / CAJA HAMBURGUESA EN CARTÓN KRAFT MICRO CANELADA

120 x 120 x 95 mm  
333120KR  
250



PERSONNALISATION - mini : 25 000 pièces

### BOÎTE HAMBURGER CARTON DÉCOR PASSE-PARTOUT / CAJA HAMBURGUESA CARTÓN DECORADO ORLA

97 x 97 x 70 mm  
333097/C  
300



100 x 100 x 80 mm  
333100  
600



### FOND CARTON HAMBURGER KRAFT BRUN AVEC PAPIER INGRAISSABLE

FONDO CARTÓN BURGER KRAFT MORENO  
CON PAPEL INGRAISSABLE

125x125x45 mm  
753125  
1000



### PLATEAU CARTON MICRO CANNELE MESETA CARTÓN MICRO ACANALADO

268 x 200 x 30 mm  
0922620  
200



## LES Pochettes BURGER

### POCHETTE HAMBURGER ALIZE ROUGE

ESTUCHE HAMBURGUESA  
ADORNO ALIZE ROJA

120 + 70 x 180 mm  
75210/C  
1000



### POCHETTE HAMBURGER ALIZE BLEU

ESTUCHE HAMBURGUESA  
ADORNO ALIZE AZUL

120 + 70 x 180 mm  
75211/C  
1000



### PAPIER INGRAISSABLE BRUN

ESTUCHE HAMBURGUESA MARRÓN PLEA PACK XL PT

350 x 500 mm  
210003550KR  
10 Kgs



### PAPIER HAMBURGER BLANC PARAFFINÉ

PAPEL PARA HAMBURGUESA BLANCO

240 x 305 mm  
77020/C  
1000



### PAPIER HAMBURGER BRUN PARAFFINÉ

PAPEL PARA HAMBURGUESA BLANCO

250 x 300 mm  
-  
-





## LES CÔNES À FRITES



### CÔNE PAPIER PETIT MODÈLE IMPRESSION JOURNAL CONO PAPEL PEQUEÑO MODELA IMPRESIÓN PERIÓDICO

175 x 175 x 240 mm  
74124  
1500 (15x100)



### CÔNE PAPIER GRAND MODÈLE IMPRESSION JOURNAL CONO PAPEL GRANDE MODELO IMPRESIÓN PERIÓDICO

205 x 205 x 265 mm  
74225  
1500 (15x100)



### CÔNE PAPIER PETIT MODÈLE KRAFT BRUN CONO PAPEL PEQUEÑO MODELA COLOR MARRÓN

175 x 175 x 240 mm  
74134  
1500 (15x100)



### CÔNE PAPIER GRAND MODÈLE KRAFT BRUN CONO PAPEL GRANDE MODELA COLOR MARRÓN

205 x 205 x 265 mm  
74135  
1500 (15x100)



## LES POCHETTES CARTON



### POCHETTE FRITES CARTON PETIT MODELE BLANC ESTUCHE PATATAS FRITAS EN CARTON ADORNO

140 g  
363140  
2000



### POCHETTE MAXI FRITES CARTON BLANC ESTUCHE MAXI PATATAS FRITAS EN CARTON ADORNO

95 x 50 x 132 mm  
160 g  
363160  
1000



## LES BARQUETTES CARTON



### BARQUETTE CARTON BLANC INGRAISSABLE BANDEJITA DE CARTÓN ADORNO BLANCA

140 x 70 x 30 mm  
3133130  
500



### BARQUETTE FRITE CARTON BLANC INGRAISSABLE BARQUETA DE FRITAS (PATATAS) CARTON ANTIGRASA

140 x 70 x 40 mm  
3133140  
500



PERSONNALISATION - mini : 25 000 pièces

## SAC KRAFT BRUN

### SAC FRITE PAPIER KRAFT BRUN BOLSA DE PAPEL COLOR MARRÓN PARA LAS PATATAS FRITAS

110 x 35 x 133 mm  
704112  
1000



## CÔNE À CRÊPE

### CÔNE À CRÊPE BLANC CARTON+PE CONO CARTÓN

150 x 135 mm  
31231150  
700



# FINGER FOOD

Idéal pour le frit, le frais aussi ou encore les plats cuisinés.

## LES BOÎTES CARTON



### BARQUETTE FIRPACK BIODÉGRADABLE 1965 ML CARTON KRAFT BRUN

BARQUILLA BIODEGRADABLE  
CARTÓN KRAFT MORENO

215x155x65 mm  
 BIO1330330  
 300



### BARQUETTE FIRPACK BIODÉGRADABLE 1324 ML CARTON KRAFT BRUN

BARQUILLA BIODEGRADABLE  
CARTÓN KRAFT MORENO

170x137x64 mm  
 BIO1330230  
 300



### BARQUETTE FIRPACK BIODÉGRADABLE 755 ML CARTON KRAFT BRUN

BARQUILLA BIODEGRADABLE  
CARTÓN KRAFT MORENO

172x106x65 mm  
 BIO1330130  
 450



### BOÎTE «TAKE AWAY» CARTON

CAJA "TAKE AWAY" CARTÓN

114 x 73 x 45 mm  
 333114  
 750

135 x 85 x 51 mm  
 333135  
 750

140 x 102 x 61 mm  
 333140  
 450



Décor passe-partout ou personnalisation possible pour ce Must de la vente à emporter !

## LES ASSIETTES SUSHI



### ASSIETTE PULPE RECTANGLE

PLATO PULPA RECTANGULAR

130 x 260 mm  
 115211326  
 300 (12x25)



### COUVERCLE RPET (PET RECYCLÉ)

TAPA PET RECICLADO

145 x 275 mm  
 115211326COV  
 300 (6x50)



### BAGUETTES CHINOISES ENVELOPPÉES

PALILLOS CHINOS EMBALADOS INDIVIDUALMENTE

200 mm  
 158000/C  
 3000 (30x100)



## LES PLUS SUSHI

### COQUILLE PULPE AVEC COUVERCLE

BANDEJA PULPA CON TAPA

183 x 125 x 60 mm  
 145183/c  
 600 (24x25)



### MINI CUISEUR VAPEUR BAMBOU Ø 75 MM

RECIPIENTE COCCIÓN VAPOR

Ø 75 x h 50 mm  
 BIO33075  
 20 x 10



## LES BOÎTES À PIZZA



**PERSONNALISATION - mini : 2 palettes**

### BOÎTE PIZZA KRAFT BLANC DÉCOR PPT CAJA PIZZA KRAFT BLANCA DECORACIÓN PPT

- 600 x 400 x 50 mm
- BPE60x40
- 50



### BOÎTE PIZZA ÉCO HAUTEUR 3CM DÉCOR PPT CAJA PIZZA ECONOMICA ALTURA 3CM DECORACION PPT

- 200 x 200 x 30 mm
- 1122120
- 100
- 260 x 260 x 30 mm
- 1121126
- 100
- 290 x 290 x 30 mm
- 1121129
- 100
- 330 x 330 x 30 mm
- 1121133
- 100
- 400 x 400 x 30 mm
- 1121140
- 100



### BOITE PIZZA AMERICAINE H.4 CM CAJA PIZZA AMERICANA ALTURA 4 CM

- 260 x 260 x 40 mm
- 1123126
- 100
- 290 x 290 x 40 mm
- 1123129
- 100
- 310 x 310 x 40 mm
- 1123131
- 100
- 330 x 330 x 35 mm
- 11231333
- 100
- 330 x 330 x 40 mm
- 1123133
- 100
- 400 x 400 x 40 mm
- 1123140
- 100



### BOITE CALZONE H.7 CM CAJA PIZZA CALZONE ALTURA 7 CM

- 280 x 170 x 70 mm
- 112412817/C
- 100
- 310 x 170 x 70 mm
- 112413117
- 150

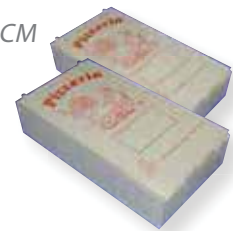

### BOÎTE TRIANGULAIRE AVEC FENÊTRE KRAFT BRUN + COUCHÉ PE COJEA TRIANGULAR CON VENTANA

- 170 x 170 x 130 mm
- 3130170/C
- 300 (4x75)

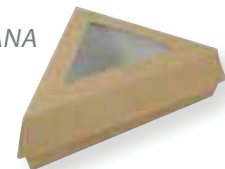

### PART PIZZA PIZZA

- 178 x 150 x 27 mm
- PARTPIZ1
- 100



# POULET

On a pas fini d'en entendre parler !

Très convivial le seau à poulet est une grande boîte en carton renforcé. Résistant aux graisses, il permet par sa capacité, de transporter des morceaux de poulet frits pour 2 à 4 personnes.

## LES SEAUX À POULET



### POT POLLO 85 OZ + COUVERCLE

CAJA POLLO 85 OZ + TAPA



8000176



6 x 43 pots + 6 x 43 couvercles



### POT POLLO 130 OZ + COUVERCLE

CAJA POLLO 130 OZ + TAPA



8000177



4 x 30 pots + 4 x 30 couvercles



## LES BOÎTES



### BARQUETTE PULPE + COUVERCLE

PLATO CUADRADA PULPA Y TAPA



200 x 150 x 78 mm



32402015



500 (2x10x25)



### BOÎTE «TAKE AWAY» CARTON

CAJA "TAKE AWAY" CARTÓN



114 x 73 x 45 mm



333114



750



135 x 85 x 51 mm



333135



750



140 x 102 x 61 mm



333140



450



## LES SACS À EMPORTER

### SAC POULET

BOLSA POLLO



180 + 70 x 360 mm



710005



500



# SOUP BAR

Gardez-moi au chaud ou au frais, comme vous préférez !



Nos solutions pour transporter vos préparations chaudes comme les soupes ou froides comme les glaces. Maintient la température de vos aliments.

## LE CARTON RENFORCÉ



### POT 24 CL EN CARTON RENFORCE

TARRINA EN CARTÓN REFORZADO 24 CL

24 cl - 8 oz  
 3040008  
 500 (20x25)

#### COUVERCLE

TAPA  
 3040012COV  
 500



### POT 36 CL EN CARTON RENFORCE

AVEC COUVERCLE / TARRINA EN CARTÓN REFORZADO CON TAPA 36 CL

36 cl - 12 oz  
 3040012  
 250 (10x25)



### POT 48 CL EN CARTON RENFORCE

AVEC COUVERCLE / TARRINA EN CARTÓN REFORZADO CON TAPA 48 CL

48 cl - 16 oz  
 3040016  
 250 (10x25)



### POT 25 OZ EN CARTON RENFORCE

TARRINA EN CARTÓN REFORZADO

73 cl - 25 oz  
 3040025  
 500 (20x25)

#### COUVERCLE

TAPA  
 3040025COV  
 500 (20x25)



### POT 96 CL EN CARTON RENFORCE

AVEC COUVERCLE / TARRINA EN CARTÓN REFORZADO CON TAPA 96 CL

96 cl - 32 oz  
 3040032  
 250 (10x25)



## LA PULPE



### POT PULPE 42,5 CL / TAPA PULPA

42,5 cl / 15 oz  
 145400  
 1000 (40x25)



### COUVERCLE PULPE / TAPA PULPA

145400COV  
 1000 (40x25)



# COQUILLES, MINI-POTS ET BARQUETTES

Solutions transport, solutions traiteur, solutions remise en température, à la portion à emporter, à réchauffer, thermoscellables, avec un couvercle intégré, transparentes, recyclables, filmables, biodégradables ...

Quand on vous dit qu'on se met en quatre pour vous, il faut nous croire !!



# COQUILLES

Avenir radieux



BARQUETTES,  
ET MINI POTS

## LA PULPE





Très résistant, couvercles attenants ou séparés, pour préparations chaudes ou froides.

### COQUILLE PULPE AVEC COUVERCLE

BANDEJA PULPA CON TAPA





 183 x 125 x 60 mm  
 145183/c  
 600 (24x25)



### COQUILLE PULPE 1 COMPARTIMENT

BANDEJA PULPA 1 COMPARTIMENTO





 200 x 150 x 78 mm  
 32402015  
 500 (2x10x25)



### COQUILLE PULPE 1 CPT

BANDEJA PULPA 1 COMPARTIMENTO





 200 x 200 x 60 mm  
 145170  
 200 (8x25)



### COQUILLE PULPE 2 COMPARTIMENTS

BANDEJA PULPA 2 COMPARTIMENTOS





 240 x 155 mm  
 345232/c  
 450 (18x25)



### COQUILLE PULPE HAMBURGER

BANDEJA PULPA PARA HAMBURGUESA





 140 x 140 x 58 mm  
 145140/C  
 1000 (40x25)



### COQUILLE PULPE 3 COMPARTIMENTS

BANDEJA PULPA 3 CPT





 245 x 240 x 81 mm  
 145220  
 250 (10x25)



### BOITE SIMPLE BURGER KRAFT BRUN

MICRO CANNELE / CAJA HAMBURGUESA  
EN CARTÓN KRAFT MICRO CANELADA





 97 x 97 x 61 mm  
 334100/C  
 720



### BOITE DOUBLE BURGER KRAFT BRUN

MICRO CANNELE / CAJA HAMBURGUESA  
EN CARTÓN KRAFT MICRO CANELADA





 110 x 104 x 75 mm  
 334110  
 600



### BOITE BURGER GÉANT KRAFT BRUN MICRO CANNELE

CAJA HAMBURGUESA EN CARTÓN KRAFT MICRO CANELADA

 120 x 120 x 95 mm  
 333120KR  
 250





## LE CARTON





### BOÎTE HAMBURGER CARTON DÉCOR PASSE-PARTOUT

CAJA HAMBURGUESA CARTÓN DECORADO ORLA

 97 x 97 x 70 mm  
 333097/C  
 300



 100 x 100 x 80 mm  
 333100  
 600





# MINI-POTS

## LES MINI-POTS PULPE ET PLA

### POT PULPE 42,5 CL



TAPA PULPA

 42,5 cl/15 oz  
 145400  
 1000 (40x25)



### COUVERCLE PULPE

TAPA PULPA



 145400COV  
 1000 (40x25)





Toute notre gamme Vision verte sur  
[www.visionverte.com](http://www.visionverte.com)

### MINI-POT «CRISTAL» PLA

MINIBOTE «CRISTAL»

 6 cl  
 BIO1360  
 2000 (20x100)





 8 cl  
 BIO1380  
 2000 (20x100)



### COUVERCLE PLA



TAPA

 BIO13COV  
 2000 (20x100)



### MINI POT EN PULPE 5,7 CL



MINIBOTE PULPA

 5,7 cl - 2oz  
 145105  
 2000 (80x25)



### POT PULPE 14 CL

BOTE DE PULPA

 14 cl / 5 oz  
 BIO826140  
 1000 (40x25)





# BARQUETTES

## LES BARQUETTES LIAISON VERTE-LIAISON FROIDE



Fabriquées en pure pâte avec protection de surface en cellulose sans aucune extrusion ou couchage de film plastique.

### BARQUETTE CARTON BIODÉGRADABLE INDIVIDUELLE GN1/8

BARQUILLA BIODEGRADABLE CARTÓN

161x111x26 mm  
BIO3230260  
1200 (16x75)



### BARQUETTE CARTON BIODÉGRADABLE INDIVIDUELLE GN 1/8

BARQUILLA BIODEGRADABLE CARTÓN

161x111x36 mm  
BIO3230360  
800



### BARQUETTE CARTON BIODÉGRADABLE INDIVIDUELLE GN 1/6

BARQUILLA BIODEGRADABLE CARTÓN

165X143X45 mm  
BIO3220450  
750 (6x125)



### ASSIETTE 180 CARTON BIODÉGRADABLE

175x175x36 mm  
BIO1210360  
1000 (4x250)



### BARQUETTE CARTON BIODÉGRADABLE 4/6 PERS. GN 1/4

BARQUILLA BIODEGRADABLE CARTÓN

265X170X48 mm  
BIO3210480  
600 (8x75)



### BARQUETTE CARTON BIODÉGRADABLE GN1/2

BARQUILLA BIODEGRADABLE CARTÓN

330X266X50 mm  
BIO3180500  
260 (2x130)



## LES BARQUETTES LIAISON VERTE-TRAITEUR



Fabriquées en pure pâte de cellulose sans aucune extrusion ou couchage de film plastique.

### BARQUETTE CARTON BIODÉGRADABLE INDIVIDUELLE 290 CC

BARQUETTE BIODEGRADABLE CARTON

161x111x26 mm  
BIO3120290  
1125



### BARQUETTE CARTON BIODÉGRADABLE INDIVIDUELLE 410 CC

BARQUETTE BIODEGRADABLE CARTON

161x111x36 mm  
BIO3120410  
750



### BARQUETTE CARTON BIODÉGRADABLE INDIVIDUELLE 625 CC

BARQUETTE BIODEGRADABLE CARTON

165x143x45 mm  
BIO3120625  
750



### BARQUETTE CARTON BIODÉGRADABLE INDIVIDUELLE 900 CC

BARQUETTE BIODEGRADABLE CARTON

215x150x48 mm  
BIO3120900  
600



### BARQUETTE CARTON BIODÉGRADABLE INDIVIDUELLE 1475 CC

BARQUETTE BIODEGRADABLE CARTON

265x170x48 mm  
BIO31201475  
600



# ASSIETTES

Formes, couleurs, matériaux, gammes complètes  
ou produits uniques, laissez-vous guider...



# ASSIETTES

Gestion durable des forêts et produits de pointe



ASSIETTES

## LES ASSIETTES «WOODY MOODY»



### ASSIETTE RONDE BOIS

PLATO DE MADERA REDONDO

Ø 155 mm  
 BIO116155/C  
 1200 (25x48)



### ASSIETTE RONDE BOIS

PLATO DE MADERA REDONDO

Ø 190 mm  
 BIO116190/C1  
 600 (6x100)



### ASSIETTE RONDE BOIS

PLATO DE MADERA REDONDO

Ø 215 mm  
 BIO116215/c  
 600 (6x100)



### ASSIETTE RONDE BOIS

PLATO DE MADERA REDONDO

Ø 225 mm  
 BIO116225  
 800 (8x100)



### ASSIETTE VAGUE BOIS

PLATO DE MADERA

Ø 230 mm  
 BIO116225  
 800



### ASSIETTE HEXAGONALE BOIS

PLATO DE MADERA  
 HEXAGONAL

Ø 260 mm  
 BIO116260  
 250



### ASSIETTE RECTANGULAIRE BOIS

PLATO DE MADERA  
 RECTANGULAR

195 x 140 x 30 mm  
 BIO330195/C  
 600 (6x100)



### ASSIETTE RECTANGULAIRE BOIS

PLATO DE MADERA  
 RECTANGULAR

265 x 215 x 20 mm  
 BIO330265/C  
 250 (1x250)



# ASSIETTES

Arrondissez les angles...

LES ASSIETTES «PULPY RONDY»



## ASSIETTE 3 COMPARTIMENTS

PLATO 3 COMPARTIMIENTOS

Ø 260 mm  
1151126/3  
500 (20x25)



## GRANDE ASSIETTE

PLATO GRANDE

Ø 260 mm  
1151126  
500 (20x25)



## MOYENNE ASSIETTE

PLATO MEDIANO

Ø 228,6 mm  
1151122  
500 (20x25)



## MOYENNE ASSIETTE OVALE

PLATO MEDIANO OVALADA

230 x 170 mm  
1151123  
600 (24x25)



## GRANDE ASSIETTE OVALE

GRANDE PLATO OVALADA

230 x 320 mm  
1154132  
500 (20x25)



## PETITE ASSIETTE

PEQUEÑO PLATO

Ø 170 mm  
1151117/C2  
1000 (40x25)



Résistantes et étanches aux sauces et aux graisses. Confort identique voir meilleur au plastique traditionnel. Résiste à l'eau et à l'huile à 100°C. Micro-onidable jusqu'à 220°C et scellable.



## LES ASSIETTES CARTON



### ASSIETTE BLANCHE Ø 150 MM

PLATO BLANCO Ø 150 MM

Ø 150 mm  
111115  
1000 (10x100)



### ASSIETTE CARTON BLANCHE Ø 180 MM

PLATO CARTÓN BLANCO Ø 180 MM

Ø 180 mm  
111118  
1000 (10x100)



### ASSIETTE ECO BLANCHE Ø 230 MM

PLATO ECONÓMICO BLANCO Ø 230 MM

Ø 230 mm  
111123  
1000 (10x100)



### ASSIETTE CARTON RECTANGLE

PLATO RECTANGULAR

100x160 mm  
ACR1016  
3000



### ASSIETTE CARTON RECTANGLE

PLATO RECTANGULAR

160x200 mm  
ACR1620  
1000



### ASSIETTE CARTON RECTANGLE

PLATO RECTANGULAR

130x200 mm  
ACR1320  
1500



### ASSIETTE CARTON RECTANGLE

PLATO RECTANGULAR

210x300 mm  
ACR2130  
250



# ASSIETTES

On se plie en quatre !

## LES ASSIETTES «PULPY SQUARY»



**ASSIETTE PULPE CARREE 170 MM**  
PLATO PULPA CUADRADO

170 x 170 mm  
 1152117  
 300 (12x25)



**COUVERCLE PET (PET RECYCLÉ)**  
TAPA PET RECICLADO

180 x 180 mm  
 1152117COV  
 300 (6x50)



**ASSIETTE PULPE CARREE 210X210 MM**  
PLATO PULPA CUADRADO

210 x 210 mm  
 1152121  
 300 (12x25)



**COUVERCLE PET (PET RECYCLÉ)**  
TAPA PET RECICLADO

1152121COV  
 300 (6x50)



**ASSIETTE PULPE CARREE BLANCHE 250X250 MM**  
PLATO PULPA CUADRADO BLANCO 250X250 MM

250 x 250 x 20 mm  
 1152125  
 300 (12x25)



**ASSIETTE COCKTAIL PULPE 250X250 MM**  
EMPLAC. VERRE

*BASE CÓCTEL REDUCE GM EMPLAC. VIDRIO*

250 x 250 mm  
 1155125  
 300 (12x25)



**ASSIETTE COCKTAIL PULPE 210X210 MM**  
EMPLAC. VERRE

*BASE CÓCTEL REDUCE PM 210X210 MM EMPLAC. VIDRIO*

210 x 210 mm  
 1155121  
 300 (12x25)



Solutions durables

**BOL PULPE BLANC 25 CL**  
BOL DE PULPA BLANCO

150 x 150 x 40 mm  
 145115  
 300 (12x25)



**COUVERCLE PET TRANSPARENT**  
TAPA PET TRANSPARENTE

165 x 160 x 40 mm  
 145115COV  
 300 (6x50)



**ASSIETTE PULPE RECTANGLE**  
PLATO PULPA RECTANGULAR

130 x 260 mm  
 115211326  
 300 (12x25)



**COUVERCLE PET (PET RECYCLÉ)**  
TAPA PET RECICLADO

145 x 275 mm  
 115211326COV  
 300 (6x50)



Hier encore considéré comme un résidu inutile, la pulpe de canne à sucre est aujourd'hui la solution unique 100% biodégradable et compostable.



# DESSERTS

Toutes les matières, toutes les formes et tous les usages...  
Une famille étendue qui ravira les plus gourmands.



# DESSERTS

## LES GLACES PULPE ET PLA



**POT PULPE 14 CL**  
BOTE DE PULPA

14 cl / 5 oz  
BIO826140  
1000 (40x25)

**BOL 30 CL**  
TAZON 30 CL

30 cl  
145130/C  
1800 (25x72)

**COUPE À DESSERT PLA VERTE TRANSPARENT**  
21 CL / COPA DE POSTRE PLA BLANCA

21 cl  
BIO14170  
800 (8x100)

**POT PULPE 42,5 CL / TAPA PULPA**

42,5 cl / 15 oz  
145400  
1000 (40x25)

**COUVERCLE PULPE / TAPA PULPA**

145400COV  
1000 (40x25)

**CUILLERE À DESSERT ASSORTIE VERT ET BLANC / CUCHARA**

95 mm  
BIO15095  
10 kg soit 7000 unités

**COUPE À DESSERT PLA BLANC TRANSPARENT**  
8 CL / COPA DE POSTRE PLA BLANCA

8 cl  
BIO14080  
1200 (12x100)

## LES GLACES CARTON



**POT À GLACE 2 BOULES DÉCOR PASSE-PARTOUT**  
POTE A HIELO 2 BOLAS DECORADO ORLA

2 boules  
3040026/C  
1750 (35x50)

**POT À GLACE 3 BOULES DÉCOR**  
POTE A HIELO 3 BOLAS DECORADO ORLA

3 boules  
3040027  
1200 (24x50)

**POT 24 CL EN CARTON RENFORCE**  
TARRINA EN CARTÓN REFORZADO 24 CL

24 cl - 8 oz  
3040008  
500 (20x25)

**COUVERCLE / TAPA**

3040012COV  
500



**POT 36 CL EN CARTON RENFORCE AVEC COUVERCLE**  
TARRINA EN CARTÓN REFORZADO CON TAPA 36 CL

36 cl - 12 oz  
3040012  
250 (10x25)

Retrouvez tous nos pots carton p.34

**BOÎTE PÂTISSÈRE BLANCHE**



CAJA PASTELERÍA BLANCA

 140 x 60 mm  
 100000  
 50



**BOÎTE PÂTISSÈRE BLANCHE**



CAJA PASTELERÍA BLANCA

 110 x 110 x 40 mm  
 100100  
 100



**BOÎTE PÂTISSÈRE BLANCHE A POIGNÉE**



CAJA PASTELERÍA BLANCA CON ASAS

 105 x 100 x 55/110 mm  
 120032  
 50



**BOÎTE PÂTISSÈRE BLANCHE A POIGNÉE**



CAJA PASTELERÍA BLANCA CON ASAS

 170 x 100 x 45/90 mm  
 120028  
 50



**BOÎTE PÂTISSÈRE BLANCHE A POIGNÉE**



CAJA PASTELERÍA BLANCA CON ASAS

 170 x 155 x 55/11 mm  
 120029  
 50



**BOÎTE PÂTISSÈRE BLANCHE A POIGNÉE**



CAJA PASTELERÍA BLANCA CON ASAS

 180 x 180 x 6/12 mm  
 120033  
 50



**CAISSETTE SANS COUVERCLE BLANCHE**

CAJA PASTELERIA BLANCA

 140 x 100 x 50 mm  
 120001  
 100





Décor passe-partout, personnalisation possible !

Découvrez toute notre gamme  
Boulangerie Pâtisserie p.142



**CAISSETTE SANS COUVERCLE BLANCHE**



CAJA PASTELERIA BLANCA

 180 x 120 x 50 mm  
 120003  
 100



**CAISSETTE SANS COUVERCLE BLANCHE**



CAJA PASTELERIA BLANCA

 160 x 110 x 50 mm  
 120002  
 100



**BOÎTE CARRÉE AVEC FENÊTRE KRAFT BRUN 65 X65 MM**



COJEA CUADRADA CON VENTANA

 65 x 65 x 40 mm  
 120074  
 300 (12x25)



**BOÎTE CARRÉE AVEC FENÊTRE KRAFT BRUN 95 X 95 MM**



COJEA CUADRADA CON VENTANA

 95 x 95 x 40 mm  
 120075  
 300 (12x25)



**BOÎTE TRIANGULAIRE AVEC FENÊTRE KRAFT BRUN + COUCHÉ PE**

COJEA TRIANGULAR CON VENTANA



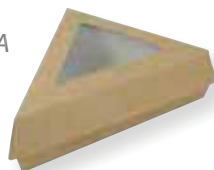

 170 x 170 x 130 mm  
 3130170/C  
 300 (4x75)







LES SACS

**SAC PAPIER KRAFT BRUN DÉCOR PASSE PARTOUT**

BOLSA BANDOLERA

 140 x 90 x 240 mm  
 1 kg  
 770300  
 1000

 200 x 90 x 290 mm  
 2 kg  
 770301  
 500





# COUVERTS



# COUVERTS

2 matériaux pour vous contenter



## LES COUVERTS CPLA



**COUTEAU BIODEGRADABLE AMIDON DE MAIS**  
CUCHILLO BIODEGRADABLE ALMIDÓN DE PERO



165 mm  
BIO1521170/C  
1000 (20x50)



**FOURCHETTE BIODEGRADABLE AMIDON DE MAIS**  
BANDA BIODEGRADABLE ALMIDÓN DE PER



165 mm  
BIO151170/C  
1000 (20x50)



**CUILLÈRE BIODEGRADABLE AMIDON DE MAIS**  
CUCHARA BIODEGRADABLE ALMIDÓN DE PERO



160 mm  
BIO1531170/C  
1000 (20x50)



**CUILLÈRE À DESSERT AMIDON DE MAIS**  
CUCHARA ALMIDÓN DE PERO



120 mm  
BIO1541120  
2000 (20x100)



**CUILLÈRE DESSERT COULEURS VERT ET BLANC**  
CUCHARA DE POSTRE PLA VERDE Y BLANCA



95 mm  
BIO15095  
10 kg soit 7000 unités

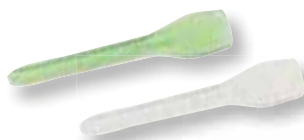

**FOURCHETTE BOIS**  
TENEDOR DE MADERA

165 mm  
1591119  
2000 (20x100)



## LES COUVERTS BOIS



**COUTEAU BOIS**  
CUCHILLO DE MADERA

165 mm  
1591219  
2000 (20x100)



**PETITE CUILLÈRE BOIS**  
CUCHARITA PARA POSTRE DE MADERA

140 mm  
1591125/C  
2000 (20x100)



**CUILLÈRE À SOUPE BOIS**  
CUCHARA DE MADERA

165 mm  
1591319  
2000 (20x100)



**CUILLÈRE À CAFÉ BOIS**  
CUCHARITA PARA CAFE DE MADERA

110 mm  
1591110/C  
2000 (20x100)



# COUVERTS

## L'ÉTUI COUVERTS



**PERSONNALISATION - mini : 25 000 pièces**

**ETUI COUVERT BRUN «BON APPÉTIT»**  
**+ SERVIETTE PASTEL 230 X 390 MM 2 PLIS**  
 ESTUCHE MARRON PARA CUBIERTOS «BON APPÉTIT»  
 + SERVILLETA

200 x 85 mm  
 0900302  
 600

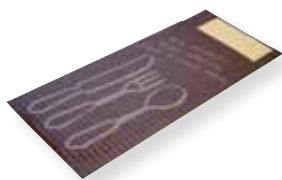

Une solution personnalisée ?  
 Contactez notre service  
 commercial à :  
[commercial@firplast.com](mailto:commercial@firplast.com)



Exemples de personnalisation

COUVERTS

## LES ACCESSOIRES BOIS



**PINCE BAMBOU PETIT MODÈLE**  
 GARRA BAMBÚ

15 mm  
 1581150  
 200 (10x20)



**PINCE BAMBOU GRAND MODÈLE**  
 GARRA BAMBÚ

90 mm  
 1581090  
 2000 (20x100)



**FOURCHETTE COCKTAIL BAMBOU**  
 TENEDOR BAMBÚ

90 mm  
 1591190  
 480 (20x24)



**CUILLÈRE COCKTAIL BAMBOU**  
 CUCHARA BAMBÚ

90 mm  
 1591390  
 480 (20x24)



**PIC SUR PIED BAMBOU**  
 PINCHO CON BASE BAMBÚ

60 mm  
 1580006  
 240 (10x24)



**BAGUETTES CHINOISES ENVELOPPÉES**  
 PALILLOS CHINOS EMBALADOS INDIVIDUALMENTE

200 mm  
 158000/C  
 3000 (30x100)



**CURE-DENTS ENVELOPPÉS INDIVIDUELLE**  
 PALILLO ENVUELTO INDIVIDUALMENTE

WT521  
 1000









# COUVERTS



## LES PIQUES ET BROCHETTES

### PIQUE DRAPEAU BAMBOU

PALILLO EXTREMO PLANO BAMBÚ

 105 mm  
 158105  
 2000 (20 x 100)



 150 mm  
 158150  
 2000 (20 x 100)

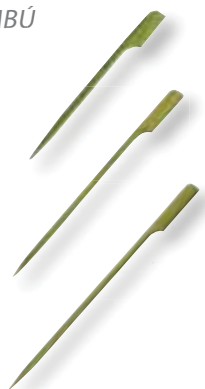

 180 mm  
 158180  
 2000 (20 x 100)





### PIQUE NOEUD BAMBOU

PALILLO NUDO BAMBÚ

 70 mm  
 1580070  
 2000 (20 x 100)

 100 mm  
 1580105  
 2000 (20 x 100)

 180 mm  
 1580180  
 2000 (20 x 100)

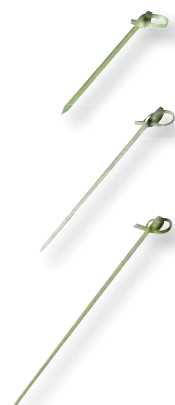

### PIQUE COCKTAIL 1 POINTE

PALILLO ÓCTEL 1 SEÑALA

 80 mm  
 WT108  
 1000



### PIQUE COCKTAIL DOUBLE POINTES

PALILLO CÓCTEL DOBLE PUNTAS

 68 mm  
 WT106  
 1000



### BROCHETTE BOIS 150 MM

PINCHO DE MADERA

 150 mm  
 WT100  
 200



### BROCHETTE BOIS 200 MM

PINCHO DE MADERA

 200 mm  
 WT104  
 200



### BROCHETTE BOIS 300 MM

PINCHO DE MADERA

 300 mm  
 WT102  
 200



### PIQUES BAMBOU FOURCHETTE

CLAVIJAS BAMBÚ BANDA

 90 mm  
 1580170  
 2000



### DÉCOR COCKTAIL BOIS

PALILLO CÓCTEL BAMBÚ

 90 mm  
 158290  
 100



 105 mm  
 1582105  
 100



 120 mm  
 1582120  
 100



### PIQUE BAMBOU BOULE

PALILLO CÓCTEL BAMBÚ

**BOULE COULEUR NATURELLE**  
 120 mm  
 1584120  
 100



**BOULE COLORIS ASSORTIS**  
 120 mm  
 1583120  
 100



# COUVERTS

## LES PAILLES PLA

### PAILLE PLA TRANSPARENTE VERTE

 Ø 5 x 200 mm  
 BIO790210/C  
 10000 (40x250)





## LES SACHETS COUVERTS

3/1

### COLLECTION «WOOD MOOD»

#### SACHET 3/1 BOIS (COUTEAU + FOURCHETTE + CUILLIÈRE)

BOLSITA DE CUBIERTOS  
3 EN 1 MADERA  
(CUCHILLO + TENEDOR  
+ CUCHARA)



 165 mm  
 1590630/C  
 300



### COLLECTION «VISION VERTE»

#### SACHET 3/1 ABDP (COUTEAU + FOURCHETTE + SERVIETTE)

BOLSA DE CUBIERTOS  
DE MADERA  
(CUCHILLO + TENEDOR  
+ SERVILLETA)

 270x75x15 mm  
 BIO1500630  
 500





4/1

### COLLECTION «VISION VERTE»

#### SACHET 4/1 ABDP (COUTEAU+FOURCHETTE +CUILLIÈRE+SERVIETTE)

BOLSA DE CUBIERTOS  
DE MADERA  
(CUCHILLO+TENEDOR  
+CUCHARA +SERVILLETA)

 215x70 mm  
 BIO1500640  
 420



# LIQUIDE



# LIQUIDE

Des gammes de gobelets pour boissons froides ou chaudes, en carton kraft, PLA, pulpe...

Les gobelets cristal transparents en PLA offrent une transparence parfaite et un choix de taille pour répondre à toutes les demandes. Pour boissons froides exclusivement.

## LES GOBELETS PLA LIGNÉ



### GOBELET «CRISTAL» PLA 250/330 ML



CUBILETE «CRISTAL» PLA 250/330 ML

7x110,8 mm (Diam.xh)  
 BIO820250  
 2100 (30x70)



### COUVERCLE PLAT PLA +TROU POUR GOBELET BIO820250

TAPA PLA

78 mm (Diam.)  
 BIO807250  
 3000 (30x100)



### GOBELET «CRISTAL» PLA 200/230 ML



CUBILETE «CRISTAL» PLA 200/230 ML

7x110,8 mm (Diam.xh)  
 BIO820200/C  
 3000 (30x100)



### GOBELET «CRISTAL» PLA 300/400 ML



CUBILETE «CRISTAL» PLA 300/400 ML

85x109,5 mm (Lxh)  
 BIO820300/C  
 1120 (16x70)



### GOBELET «CRISTAL» PLA 400/500 ML



CUBILETE «CRISTAL» PLA 400/500 ML

95x125,8 mm (Lxh)  
 BIO820400/C  
 1120 (16x70)



### GOBELET «CRISTAL» PLA 500/600 ML



CUBILETE «CRISTAL» PLA 500/600 ML

222x177x28 mm (Lxlxh)  
 BIO820500/C  
 960 (16x60)



### COUVERCLE PLAT PLA +TROU POUR GOBELET BIO820300/C, 400/C, 500/C



TAPA PLA

95 mm (Diam.)  
 BIO807345  
 1500 (30x50)



### COUVERCLE DÔME PLA +TROU POUR GOBELET BIO820300/C, 400/C, 500/C



TAPA PLA

95 mm (Diam.)  
 BIO807345D  
 1500 (30x50)



# LIQUIDE

## LES GOBELETS PULPE



Produits constitués de canne à sucre.

### GOBELET PULPE 14 CL

CUBILETE PULPA

14 cl / 5 oz  
 BIO826140  
 1000 (40x25)



### GOBELET PULPE 37 CL

CUBILETE PULPA

37 cl / 13 oz  
 BIO826300  
 500 (20x25)



### GOBELET PULPE 20/26 CL

CUBILETE PULPA

20/26 cl / 9 oz  
 BIO826200  
 750 (30x25)



### POTS BOISSONS CHAUDES OU FROIDES PULPE 42,5 CL

BOTES ZUMOS CALIENTES O FRIOS PULPA 42,5 CL

42,5 cl  
 145400  
 1000 (40x25)



### COUVERCLE

TAPA

42,5 cl  
 145400COV  
 1000 (40x25)



## LES GOBELETS CARTON



Produits constitués de fibres de bois recyclées.

### GOBELET CARTON BLANC 25/30 CL - 12 OZ

VASO BLANCO 25/35 CL - 12 OZ

25/30 cl  
 8000111  
 2000 (25x80)

### COUVERCLE

TAPA

25/30 cl  
 10LGC12  
 2000



Firplast vous propose une large gamme de gobelets en carton, dans toutes les tailles et tous les décors, y compris le vôtre !



**PERSONNALISATION - mini : 50 000 pièces**

### GOBELET CARTON BLANC 40/48 CL - 16 OZ

VASO BLANCO 40/48 CL - 16 OZ

40 cl  
 8000112  
 1000 (20x50)

### COUVERCLE

TAPA

10LGC16  
 1000 (10x100)



### GOBELET CARTON BLANC 50/60 CL - 22 OZ

VASO BLANCO 50/60 CL - 22 OZ

50 cl  
 8000113  
 1000 (20x50)

### COUVERCLE

TAPA

10LGC16  
 1000 (10x100)





# LIQUIDE

## LES Gobelets carton ondulé double paroi noir



Produits constitués de fibres de bois recyclées.

### Gobelet carton ondulé double paroi noir 10 CL - 4 OZ / VASO 10 CL - 4 OZ

 10 cl  
 8000671  
 2000



### Gobelet carton ondulé double paroi noir 17 CL - 6 OZ / VASO 17 CL - 6 OZ

 17 cl  
 8000672  
 1200 (30x40)



### Gobelet carton ondulé double paroi noir 27 CL - 10 OZ / VASO 27 CL - 10 OZ

 27 cl  
 8000673  
 1200 (30x40)





LIQUIDES

## LES PAILLES

### Paille transparente verte bio en PLA PAJA TRANSPARENTE VERDE EN PLA



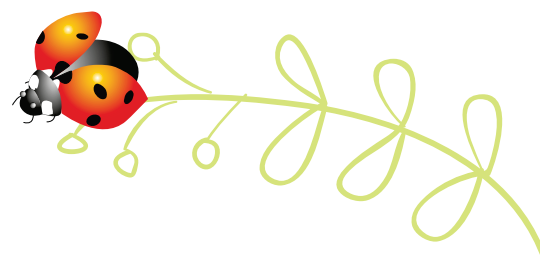

 200 mm Ø 5 mm  
 BIO790210/C  
 10000 (40x250)





## LES PORTE-Gobelets cellulose

### Porte gobelet 2 gobelets LLEVA 2 CUBILETES

 205x104x45 mm  
 18122111/C  
 460



### Porte gobelet 4 gobelets LLEVA 4 CUBILETES

 210x205x46 mm  
 18142121/C2  
 350



## LES Gobelets Carton Kraft Brun



### Gobelet Carton Kraft Brun 10 cl

CUBILETE CARTÓN KRAFT MORENO

10 cl / 4 oz  
 8000178  
 3000



### Couvercle Blanc Dome

TAPA BLANCA

4 oz  
 10LGC4  
 3000 (30x100)



### Couvercle Blanc Plat

TAPA CUPULA BLANCA

4 OZ  
 10LGC4S/C  
 1000



### Gobelet Carton Kraft Brun 18 cl

CUBILETE CARTÓN KRAFT MORENO

18 cl / 6 oz  
 8000182  
 1500



### Couvercle Blanc Plat

TAPA BLANCA

6 oz  
 10LGC6  
 2000 (20x100)



### Couvercle Blanc Dôme

TAPA CUPULA BLANCA

6 oz  
 10LGC6B  
 1000 (10x100)



### Gobelet Carton Kraft Brun 25/30 cl

CUBILETE CARTÓN KRAFT MORENO

25 cl / 10 oz  
 8000179/C  
 1500



### Couvercle Blanc Dôme

TAPA BLANCA

10 oz  
 10LGC10S  
 1000 (10x100)



# LIQUIDE

... ou préférez l'avenir radieux !

LES GOBELETS EN CARTON AVEC COUCHÉ EN CPLA, POUR LES BOISSONS CHAUDES,  
ENTIÈREMENT COMPOSTABLES ET BIODÉGRADABLES.



## GOBELET CARTON/PLA 10 CL

CUBILETE CARTÓN BIODEGRADABLE

- 10 cl / 4 oz
- BIO800100/C
- 2500 (20x50)



## COUVERCLE PLAT CPLA

TAPA CPLA

- 
- BIO808100
- 1000 (10x100)



## GOBELET CARTON/PLA 20 CL

CUBILETE CARTÓN BIODEGRADABLE

- 20 cl / 8 oz
- BIO800200
- 1000 (20x50)



## COUVERCLE DÔME CPLA

TAPA CPLA

- 
- BIO808200
- 1000 (20x50)



LIQUIDES

## LES ACCESSOIRES

### SPATULE BOIS

PALETINAS DE MADERA

- 110x5 mm
- 1580110
- 10000 (10x1000)



- 140x5 mm
- 1580140
- 10 000 (10x1000)





# ÉVÈNEMENTIEL



## GOBELET «RUGBY»+COUVERCLE 570 ML POLYPROPYLÈNE INJECTÉ TRANSPARENT

CUBILETE «RUGBY» + TAPA

 110x130x155 mm (Lxlxh)  
 891557  
 90



## LANYARD À PORTE-GOBELET

CORDÓN A PUERTA-CUBILETE



## CENDRIER DE POCHE

CENICERO DE BOLSILLO



  
  



## LES DOGGY BAG

### SAC KRAFT BRUN LISSE AVEC POIGNÉES TORSADÉES PAPIER

BOLSA KRAFT MORENO CON PUÑADOS RETORCIDOS DE PAPEL

 110 x 110 x 390 mm  
 KVNBB  
 20





Sac idéal pour le transport d'une bouteille. Il est aussi personnalisable avec des étiquettes.

Sac idéal pour le transport d'une bouteille et d'un plat

### SAC CABAS KRAFT BRUN

BOLSA CAPACHO KRAFT MORENO



 260 x 140 x 320 mm  
 7122632  
 250



à composer avec :

### BOÎTE FIRPACK CARTON BRUN 755 ML



COJEA KRAFT PARDO

 127 x 106 x 65 mm  
 BIO1330130  
 450



### POT ROND PLA 40 CL

POTE REDONDO

 40 cl - 16 OZ  
 BIO146016/C  
 500 (10x50)



# ÉVÈNEMENTIEL



## LE GOBELET RÉUTILISABLE CONSIGNÉ, UNE SOLUTION ÉCO-RESPONSABLE

### LES ENJEUX ÉCOLOGIQUES

Petit à petit, geste après geste, l'addition de tous les efforts individuels peut avoir des effets positifs sur l'environnement.

Le milieu événementiel est un lieu idéal pour mener des actions d'éducation à l'environnement. Un festival, un concert, une rencontre sportive, une animation culturelle attirent un public nombreux. C'est l'occasion de sensibiliser des publics différents au développement durable et de vérifier l'efficacité d'un concept. Le bilan écologique est désormais un paramètre important de réussite d'une manifestation, souvent pris en compte dans les médias et toujours apprécié par les populations locales.

### UN GESTE SIMPLE POUR L'ENVIRONNEMENT



Fonctionnant à la manière des sacs réutilisables en supermarché, les gobelets réutilisables permettent aux organisateurs de s'engager dans une démarche pour la planète et d'éviter les frais de nettoyage du site, tout en faisant prendre conscience aux utilisateurs des enjeux écologiques, à travers un acte simple "boire dans un gobelet réutilisable" qui devient un acte éco-responsable.

Facile à gérer pour les organisateurs, simple à utiliser pour les participants, le gobelet réutilisable s'intègre dans toutes les manifestations. Il suffit aux participants d'acheter un gobelet réutilisable avec consigne, de le garder sur eux grâce à des accessoires (clips, cordons), de s'en resservir à volonté et de le rendre au terme de la manifestation contre remboursement de la consigne. Ce gobelet sera lavé et pourra resservir (150 lavages possibles) ou être recyclé. Le gobelet, bel objet marqué comme support de communication, pourra aussi être conservé en souvenir de la manifestation.

## VERRES RÉUTILISABLES

### VERRE PP INJECTÉ RÉUTILISABLE DECOR PPT 33 CL



VASO REUTILIZABLE

 25-30 cl / 11,6 oz  
 8911033PPT  
 300 (15x20)



### VERRE PP INJECTÉ TUBO GIVRÉ



VASO REUTILIZABLE



 26 cl  
 8914026  
 100 (10x10)



### VERRE PP INJECTÉ RÉUTILISABLE 33 CL

VASO REUTILIZABLE

 33 cl / 11,6 oz  
 8911033  
 300 (15x20)

 60 cl  
 8911060  
 300 (15x20)



## PICHET RÉUTILISABLE

### PICHET PP RÉUTILISABLE

JARRO REUTILIZABLE

 1 L  
 8214100/C  
 120 (8x15)



# ÉVÈNEMENTIEL

## LE PRINCIPE DE CAUTION



Donner 1 € en échange d'un gobelet

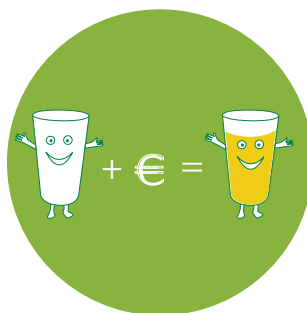

Une fois le gobelet payé, acheter sa boisson



Rendre son gobelet pour récupérer 1 €  
ou Garder son gobelet

Tous les verres mis à disposition pour les utilisateurs sont consignés : la caution s'élève à 1 euro.

A tout moment, l'utilisateur peut récupérer sa caution en rendant son verre à l'endroit prévu à cet effet. Il récupère alors 1 euro.

Tout en œuvrant pour le développement durable, le geste qu'il a accompli ne lui a rien coûté. Facile !

Si l'utilisateur décide de garder son verre en souvenir, il ne récupère pas de caution. L'organisateur l'encaisse alors définitivement.

Le principe de distribution des gobelets contre caution s'adapte au fonctionnement de votre événement.

Cas 1 : la distribution des gobelets et la restitution des cautions se font au bar. Le consommateur commande une boisson. S'il n'a pas de gobelet, sa première consommation est majorée de 1 euro. Pour rendre son verre, l'utilisateur le dépose au bar et récupère sa caution.

Cas 2 : la distribution des gobelets et la restitution des cautions se font sur une partie réservée du bar

Avant de commander une boisson, l'utilisateur va à l'endroit réservé «stand caution». Il paie sa caution, récupère un verre et se rend vers l'autre partie du bar pour consommer. Lorsqu'il veut rendre son verre, l'utilisateur se rend à l'endroit réservé «stand caution». Il dépose son verre et récupère sa caution.

Cas 3 : la distribution des gobelets et la restitution des cautions se font dans des stands indépendants du bar

Avant de commander sa boisson, l'utilisateur va au stand « gobelets ». Il paie sa caution, récupère un verre et se rend au bar pour consommer. Lorsqu'il veut rendre son verre, l'utilisateur va au stand « gobelet ». Il dépose son verre et récupère sa caution.

Dans les 3 cas : Si son verre est sale, le bar peut échanger son verre contre un propre. Si son verre est vide, le bar remplit le verre ou l'échange contre un plein déjà préparé.

Les affiches FIRPLAST propose des affiches à installer près des bars et des points de caution pour expliquer le fonctionnement du système.

Il existe différents modèles d'affiches et des tailles différentes :

Taille 1 : 70 X 100 cm, Taille 2 : 40 X 60 cm, Taille 3 : A4 (21 X 29,7 cm)

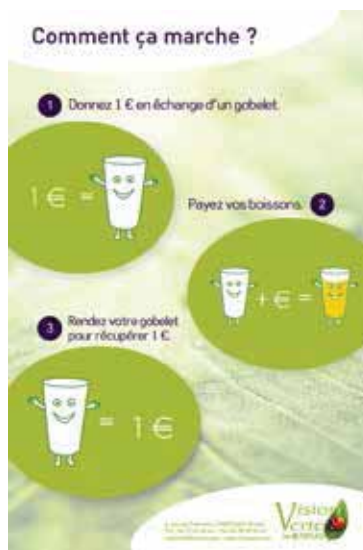



J'achète !

Tous les verres mis à votre disposition sont vendus. Vous assurez alors la pleine gestion de votre stock (lavage, conditionnement...). FIRPLAST vous facture l'achat, la personnalisation et le transport des verres. Vous souhaitez acheter des verres sans les personnaliser: FIRPLAST vous propose l'achat de verres réutilisables, vierges de toute inscription.

## LA LOCATION : COMMENT ÇA MARCHE ?

Ainsi, FIRPLAST vous propose 3 formules de location, afin de répondre au mieux à vos besoins :

1- Formule « Location » : Tous les verres mis à disposition sont loués

Type de verre : Verre neutre, sans impression ou verre avec une impression «passe partout».

Facturation : Lavage (0,1 € par gobelet sale) + Transport + 0.70 € par gobelet non restitué (avec la caution à 1 euro d'un verre non restitué, vous réalisez un bénéfice de 0,30 € TTC sur chaque gobelet).

2- La Formule « Achat + Location + Lavage partiel »

Type de verre : Verre neutre sans impression + Verre imprimé.

Facturation : pour les verres sans impression : Lavage (0,1 € par gobelet sale) + Transport + 0.70 € TTC par gobelet non restitué (avec la caution à 1 € d'un verre non restitué, vous réalisez un bénéfice de 0,30 € TTC sur chaque gobelet). Pour les gobelets personnalisés : Achat des verres (tarif en fonction du nombre de couleurs et de la quantité).

3- La Formule « Achat + Location + Lavage »

Type de verres : Verre neutre sans impression + Verre imprimé (représentant au minimum 50% de la quantité totale de verres).

Facturation : pour les verres sans impression : Lavage (0,1 € par gobelet) + Transport + 0.70 € par gobelet non restitué (avec la caution à 1 € d'un verre non restitué, vous réalisez un bénéfice de 0,30 € TTC sur chaque gobelet) / pour les gobelets personnalisés : Uniquement les frais d'impression + Lavage (0,1 € par gobelet sale) + Transport + 0.70 € par gobelet non restitué (avec la caution à 1 euro d'un verre non restitué, vous réalisez un bénéfice de 0,30 € TTC sur chaque gobelet).

Les verres personnalisés sont ensuite lavés et stockés chez FIRPLAST puis remis à votre service l'année suivante si vous continuez le partenariat avec FIRPLAST.

	Location gobelets neutres ou impression PPT	Location gobelets personnalisés	Achat gobelets personnalisés	Frais d'impression	Lavage	Rétrocession Consigne	Transport retour
Formule 1 Location	✓				✓	✓	✓
Formule 2 Achat + Location et lavage partiel	✓		✓		Gobelets neutres ou impression passe partout	Gobelets neutres ou impression passe partout	Gobelets neutres ou impression passe partout
Formule 3 Achat + Location + Lavage	✓	✓		✓	✓	✓	✓

# SACHERIE ET TRANSPORT







# SACHERIE ET TRANSPORT

## LES SACS BRETELLE

Préservez la planète, SI SI C'EST POSSIBLE !!

### SAC BRETELLE EN OXO BIODÉGRADABLE 13 µ



BOLSA BANDOLERA 13 µ

 260 x 60 x 450 mm  
 BIO2645  
 2000



### SAC BRETELLE BIODÉGRADABLE 14 µ



BOLSA BANDOLERA 14 µ

 260 x 60 x 450 mm  
 BIO2645/1  
 2000



### SAC BRETELLE EN OXO BIODÉGRADABLE 15 µ

BOLSA BANDOLERA 15 µ



 300 x 70 x 540 mm  
 BIO3054  
 2000



## LES SACS CABAS PP TISSÉS RÉUTILISABLES

### SAC CABAS PP TISSÉ RÉUTILISABLE BLANC



BOLSA CAPACHO

 400+200x400 mm  
 5804020  
 100



### SAC CABAS ARBRE



BOLSA CAPACHO

 400+200x400 mm  
 -  
 100



### SAC CABAS PP TISSÉ RÉUTILISABLE BRUN

BOLSA CAPACHO

 400+200x400 mm  
 -  
 100





# SACHERIE ET TRANSPORT

S.O.S : l'indispensable

## LE WHITE

### SAC SOS 3 REPAS KRAFT BLANC



BOLSA PARA LLEVAR 3 COMIDAS BLANCA

 180 + 110 x 340 mm  
 702118  
 500



### SAC SOS GEANT KRAFT BLANC

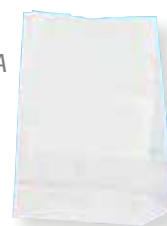

BOLSA GIGANTE PARA LLEVAR BLANCA

 250 + 150 x 430 mm  
 10SOSGBL  
 250



### SAC SOS KRAFT BLANC

BOLSA PARA LLEVAR BLANCA

 120 + 80 x 240 mm  
 702412/C  
 1000





PERSONNALISATION - mini : 60 000 pièces

## LE BROWN

### SAC SOS KRAFT BRUN



BOLSA PARA LLEVAR KRAFT MARRÓN

 120 + 80 x 240 mm  
 702413  
 1000



### SAC SOS GEANT KRAFT BRUN



BOLSA GIGANTE PARA LLEVAR KRAFT MARRÓN

 250 + 150 x 430 mm  
 702414  
 250



### SAC SOS KRAFT BRUN



BOLSA PARA LLEVAR KRAFT MARRÓN

 180 + 110 x 340 mm  
 7221834  
 500



### SAC SOS KRAFT BRUN

BOLSA PARA LLEVAR KRAFT MARRÓN

 180 + 120 x 290 mm  
 702416  
 1000









PERSONNALISATION - mini : 100 000 pièces

## LES SACS À FRUITS

### SAC BRETLE EN OXO BIO DÉGRADABLE

BOLSA BANDOLERA



 140 + 90 x 240 mm - 1 kg  
 770300  
 1000

 200 + 90 x 290 mm - 2 kg  
 770301  
 500



### SAC SOS REPAS ALIZÉ

BOLSA PARA LLEVAR COMIDA ADORNO ALIZE

 180 + 110 x 340 mm  
 702418  
 500



# SACHERIE ET TRANSPORT



Le cabas, un must.

Personnalisable, entièrement recyclable. D'autres modèles disponibles sur commande.

## LE WHITE

### SAC CABAS KRAFT BLANC 200/100 MM



BOLSA CON ASAS BLANCA

 200 + 100 x 320 mm  
 10SA20B  
 250



### SAC CABAS KRAFT BLANC 260/140 MM



BOLSA CON ASAS BLANCA

 260 + 140 x 320 mm  
 10SA26B  
 250



### SAC CABAS KRAFT BLANC 260/170 MM



BOLSA CON ASAS BLANCA



 260 + 170 x 250 mm  
 7112625  
 250



### SAC CABAS KRAFT BLANC 320/200 ET 260/170 MM

BOLSA CON ASAS BLANCA

 320 + 200 x 230 mm  
 7113224  
 250



 260 + 170 x 250 mm  
 7112625  
 250



## LE BROWN

### SAC CABAS KRAFT BRUN 260/140 MM



BOLSA CON ASAS MARRÓN

 260 + 140 x 320 mm  
 7122632  
 250



### SAC CABAS KRAFT BRUN 260/170 MM



BOLSA CON ASAS MARRÓN

 260 + 170 x 250 mm  
 7112625KR  
 250



### SAC CABAS KRAFT BRUN 320/150 MM



BOLSA CON ASAS MARRON

 320 + 150 x 350 mm  
 7113225KB  
 250



### SAC CABAS KRAFT BRUN 320/160 MM

BOLSA CON ASAS MARRÓN



 320 + 160 x 440 mm  
 7123244  
 250





## LE TORSADÉ

### SAC CABAS POIGNÉES TORSADÉES KRAFT BLANC

BOLSA CON ASAS BLANCA



 180 + 80 x 200 mm  
 SKBLL18825  
 300



 240 + 110 x 310 mm  
 SKBLL221231  
 250





### SAC CABAS POIGNÉES TORSADÉES KRAFT BRUN

BOLSA CON ASAS BLANCA

 180 + 80 x 240 mm  
 SKBRL18821  
 400



 220 + 120 x 310 mm  
 SKBRL221031  
 200

 320 + 120 x 410 mm  
 SKBRL321241/C  
 250



### SAC CABAS KRAFT BRUN 320/200 MM



BOLSA CON ASAS MARRÓN



 320 + 200 x 230 mm  
 7113224KR  
 250



### SAC CABAS POIGNÉES TORSADÉES KRAFT ROUGE

BOLSA CON ASAS BLANCA

 240 x 120 x 310 mm  
 250900RO  
 250

 350 x 140 x 440 mm  
 250901RO  
 200



Différents coloris disponible. Nous consulter

 PERSONNALISATION - mini : 5 000 pièces



# SACHERIE ET TRANSPORT

Simplifiez-vous la vie

## LES CAISSES TRAITEUR

### CAISSE TRAITEUR KRAFT BLANC



CAJA DE PRESENTACIÓN KRAFT BLANCA

 660 x 450 x 100 mm  
 350336/C  
 30



### CAISSE TRAITEUR KRAFT BRUN

CAJA DE PRESENTACIÓN KRAFT MARRÓN



 370 x 300 x 70 mm  
 350338KB  
 30



## LES COFFRETS TRANSPORT

### BOÎTE TRAITEUR KRAFT MICRO CANELURE



CAJA DE RESTURACIÓN KRAFT MICRO TIRAS

 420 x 280 x 60 mm  
 F5742  
 25



### COFFRET BLANC LIVRAISON A DOMICILE



CAJA PARA ENTREGA A DOMICILIO

 400 x 300 x 70 mm  
 20BT395ECO  
 50



### COFFRET TRANSPORT POUR 4 PLATEAUX «CUBE»

COJEA TRANSPORTE PARA 4 BANDEJAS

 -  
 12013CUBE  
 25





Tous nos plateaux repas p.113

## Une alternative au blanc

### COFFRET PRESTIGE

CIFRECITO PRESTIGIO

 400 x 300 x 70 mm  
 20BT395PPT  
 50

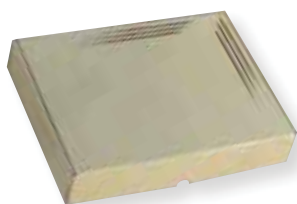



Fonctionne aussi en plateau repas



### PLATEAU «BENTO» CARTON



BANDEJA «BENTO»

 320 x 140 x 90 mm  
 1200320  
 100



### ETUI KRAFT BRUN + CALAGE

ESTUCHE KRAFT MARRÓN + CALADO

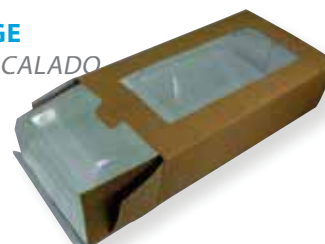

 340 x 180 x 90 mm  
 1200340  
 50



## LES BOITES REPAS

### BOÎTE REPAS COMPLET EN KRAFT BLANC

CAJA PARA LLEVAR COMIDA EN BLANCO

 255 x 190 x 160 mm  
 0085559/C  
 140





Boîte de portage de repas et poignée de transport. La boîte kraft blanc possède un emplacement spécial boisson ou dessert.

Livrée à plat pour gagner de la place.

### BOÎTE «DINOSAURES»



CAJA «DINOSAURIO»

 152 x 100 x 102 mm  
 10BEDINOS  
 250



### BOÎTE «TRESOR»



CAJA «TESORO»

 152 x 100 x 102 mm  
 10BETRESOR  
 250



### BOÎTE «JUNGLE»



CAJA «SELVA»

 152 x 100 x 102 mm  
 10BEJUNGLE  
 250



### BOÎTE «CIRCUS CLOWN»

CAJA «PAYASO DE CIRQUE»

 152 x 100 x 102 mm  
 10BECIRCUS  
 250





## LES PORTE-GOBELETS



### PORTE 2 GOBELETS



PORTA 2 VASOS

 205 x 104 x 45 mm  
 18122111/C  
 460



### PORTE 4 GOBELETS

PORTA 4 VASOS

 210 x 205 x 46 mm  
 18142121/C2  
 350



100% compostable et biodégradable constitué de fibres de bois recyclé ou de canne à sucre !

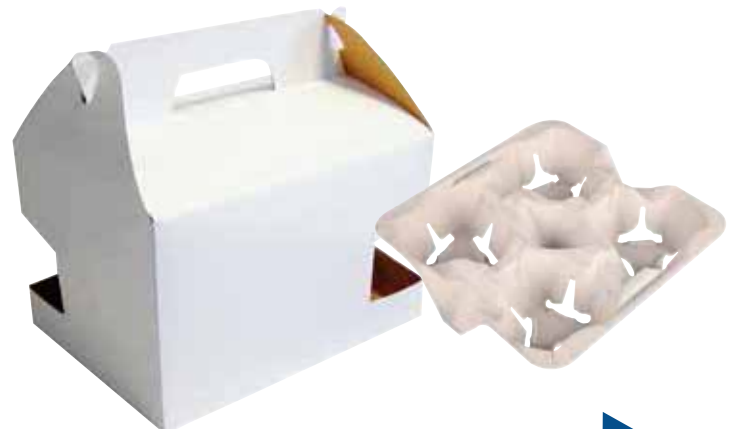

# MISES EN BOUCHE



# MISES EN BOUCHE

Toutes nos verrines sur notre site [www.firplast.com](http://www.firplast.com)

Découvrez toutes nos collections «Verrines» sur notre catalogue «Tenue de soirée» et sur notre site [www.firplast.com](http://www.firplast.com)

## COLLECTION «VISION VERTE»



### VERRINE PULPE «1/2 OEUF» RECIPIENTE PULPA «SEMIOAVALADO»



80 x 55 x 30 mm  
1451078  
1000 (4x25)



### VERRINE PULPE «FEUILLE» RECIPIENTE PULPA «HOJA»



105 x 51 x 29 mm  
1154010  
1000 (40x25)



### SERVLETTE 1 PLI NATURE ÉCOLOGIQUE SERVILLETAS 1 PLI MARON CLARO ECOLÓGICO

300 x 300 mm  
611113/C  
3200 (16x200)



### VERRINE PULPE «RONDE» RECIPIENTE PULPA «REDONDO»



Ø 105 mm  
11511105  
100 (40x25)



### VERRINE PULPE «SQUARE» RECIPIENTE PULPA «CUADRADO»



110 x 110 mm  
11521115  
1000 (40x25)



## COLLECTION «WOOD MOOD»



### RAMEQUIN «TRIO ROND» BAMBOU RAMEQUIN REDONDO «TRIPLE» BAMBU

180 x 60 mm  
1191018  
120 (10x12)



Existe aussi en «trio carré»

### VERRINE BOIS LAMPARA EN MADERA



Ø 45 x h 45 mm  
BIO809045  
1000



### FOURCHETTE ET CUILLE COCKTAIL BAMBOU TENEDOR Y CUCHARA BAMBU

90 mm  
1591190 et 1591390  
480 (20x24)



### GRANDE BARQUETTE PIN CESTA GRANDE DE PINO

170 x 85 x 20 mm  
BIO330170  
2000 (20x100)



Existe en 2 autres tailles :  
70 mm et 115x65 mm

### CUILLE «GOUTTE» BAMBOU CUCHARA «GOTA» BAMBU

90 x 36 mm  
1591309  
240 (10x24)



# MISES EN BOUCHE



## COUPELLES BAMBOU

Apportez une touche de nature à vos apéritifs avec notre gamme de verrines en bambou.

### COUPELLE RONDE CREUSE Ø 50 MM

VERRINE RONDA

Ø 50 mm  
3282554113778  
12



### COUPELLE CARRÉE BAMBOU Ø 60 MM

VERRINE CUADRADA

60x60 mm  
1192006  
240 (10x24)



### COUPELLE CARRÉE INTÉRIEUR ROND BAMBOU 60X60 MM

VERRINE CUADRADA BAMBÚ

60x60 mm  
1191206  
240 (10x24)



### COUPELLE RONDE Ø 60 MM

VERRINE RONDA

Ø 60 mm  
1191006  
10x24



## RAMEQUINS BAMBOU

### RAMEQUIN SOLO ROND BAMBOU

VERRINE CUADRADA BAMBÚ 1 CÍRCULO

80x58 mm  
3282554113769  
80



### RAMEQUIN DUO ROND BAMBOU

VERRINE DOS CÍRCULOS EN BAMBÚ

120x60 mm  
1191012  
120 (10x12)



### RAMEQUIN TRIO ROND BAMBOU

VERRINE CUADRADA BAMBÚ 3 CÍRCULOS

180x60 mm  
1191018  
120 (10x12)



### RAMEQUIN TRIO CARRÉ BAMBOU

VERRINE RECTÁNGULO 3 CUADRADOS

180x60 mm  
1192018  
240 (10x24)







# MISES EN BOUCHE

## CUILLERES BAMBOU

### CUILLÈRE GOUTTE BAMBOU



CUCHARA BAMBÚ

 90x36 mm  
 1591309  
 240 (10x24)



### CUILLÈRE PELLE BAMBOU



CUCHARA BAMBÚ

 100x30 mm  
 1591310  
 240 (10x24)



### VERRINE BOIS

VERRINE BEBO



 45 x 45 mm  
 BIO809045  
 1000



## BARQUETTES PIN

### PETITE BARQUETTE PIN



PEQUEÑA VERRINE BEBO

 70 mm  
 BIO330070  
 4000 (40x100)



### MOYENNE BARQUETTE PIN



VERRINE BEBO

 115x65 mm  
 BIO330110  
 1000 (40x100)



### GRANDE BARQUETTE PIN

GRANDE VERRINE BEBO

 170x85x20 mm  
 BIO330170  
 2000 (20x100)



# PLATEAUX REPAS ET PLATEAUX

Une petite sélection de nos «MUST».

Pour toute la gamme, consultez notre catalogue «Plateaux» ou «Tenue de soirée»



# PLATEAUX REPAS ET PLATEAUX





## Pourquoi 2 plateaux ?

Parce que plus que jamais FIRPLAST veut donner sa chance aux alternatives éco-responsables qui si elles sont suivies aujourd'hui permettront demain de vivre dans un monde harmonieux et respectueux de la nature et de la vie.

### PLATEAU PULPE RECTANGLE BLANC 5 COMPARTIMENTS



*BANDEJA PULPA 5 COMPARTIMENTOS*

 280 x 220 x 350 mm  
 1352822  
 200 (4 x 50)





### COUVERCLE POUR PLATEAU PULPE RECTANGLE BLANC

*TAPA PARA BANDEJA PULPA 5 COMPARTIMENTOS*

 295 x 240 mm  
 1352822COV  
 200 (4 x 50)





### PLATEAU PULPE 5 COMPARTIMENTS BANDEJA PULPA

 375 x 268 x 30 mm  
 1353827  
 200 (4x50)



### COUVERCLE TRANSPARENT PET

*TAPA TRANSPARENTE PET PARA BANDEJA PULPA*



 385 x 275 x 45 mm  
 1353827COV/C  
 100



Produit 100 % compostable et biodégradable constitué de canne à sucre

# PLATEAUX REPAS ET PLATEAUX

PLATEAU «FAMOUS BREAK» CARTON NOIR/VERT  
BANDEJA «FAMOUS BREAK»



 367 x 285 x 70 mm  
 1201367  
 50

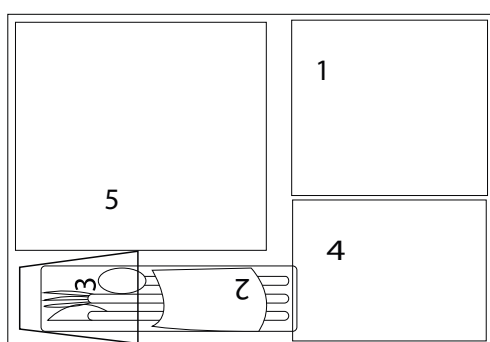

## Composition «Vision verte»





1 - BOL PULPE BLANC  
BOL DE PULPA BLANCO

 150 x 150 x 40 mm  
 145115  
 300 (12x25)





1 BIS - COUVERCLE PET TRANSPARENT  
TAPA PET TRANSPARENTE

 165x160x40 mm  
 145115COV  
 300 (6x50)





2 - SACHET COUVERTS 3 EN 1 LUXE BIODÉGRADABLE  
ABDP (COUPEAU+FOURCHETTE+SERVIETTE)  
BOLSITA DE CUBIERTOS 3 EN 1 (CUCHILLO + TENEDOR +  
SERVILLETA) BIODEGRADABLES

 -  
 BIO1500630  
 500





3 - GOBELET PULPE BLANCHE  
VASO DE PULPA BLANCO

 14 cl  
 BIO826140  
 1000 (40x25)





4 - BOITE «FIRPACK» CARTON RECYCLÉ KRAFT BRUN  
CAJA «FIRPACK» CARTÓN RECICLADO MARRÓN

 755 ml  
 BIO1330130  
 450





5 - ASSIETTE PULPE CARREE 21 CM  
PLATO DE PULPA CUADRADO

 210x210 mm  
 1152121  
 300 (12x25)



5 BIS - COUVERCLE RPET (PET RECYCLÉ)  
TAPA PET-R (PET RECICLADO)

 210x210 mm  
 1152121COV  
 300 (6x50)



# PLATEAUX REPAS ET PLATEAUX

PLATEAU «FAMOUS BREAK» CARTON NOIR/VERT  
BANDEJA «FAMOUS BREAK»

320 x 140 x 90 mm  
1200320  
100



## Composition «Vision verte»

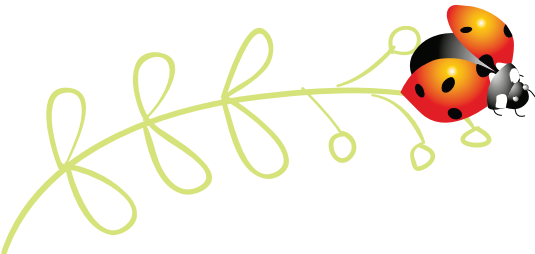
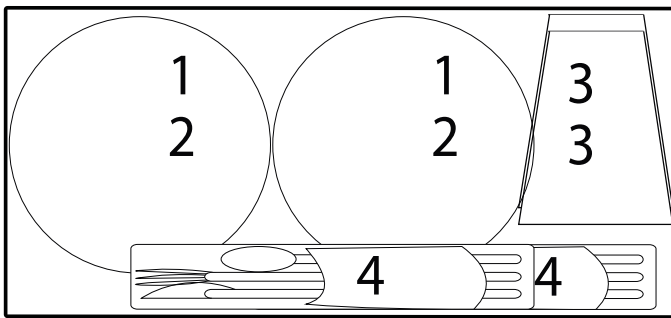

2- SALADIER ROND PLA 30 CL - 12 OZ  
ENSALADERA REDONDA PLA



30 cl - 12 oz  
BIO146012/C  
500 (10x50)



COUVERCLE PLA POUR POTS ROUNDS PLA 12/16/24 OZ  
TAPA PLA PARA BOTES REDONDOS PLA

Ø 102 mm  
BIO146000COV  
500 (10x50)



4- SACHET 4/1 PULPE ABDP (COUTEAU+FOURCHETTE  
+CUILLÈRE+SERVIETTE)  
BOLSA DE CUBIERTOS  
DE MADERA  
(CUCHILLO+TENEDOR  
+CUCHARA +SERVILLETA)



-  
BIO1500640  
420



1- SALADIER ROND PLA 24 CL - 8 OZ  
ENSALADERA REDONDA PLA



24 cl - 8 oz  
BIO146008/C  
500



COUVERCLE PLA  
ENSALADERA REDONDA PLA

Ø 102 mm  
BIO146000COV  
500 (10x50)



3- GOBELET «CRISTAL» 200/230 ML PLA  
CUBILETE «CRISTAL» PLA



-  
BIO820200/C  
3000 (30x100)





# PLATEAUX REPAS ET PLATEAUX

## L'ÉTUI KRAFT BRUN



COFFRET KRAFT BRUN + COUCHÉ PE AVEC FENÊTRE  
+ CALAGE

BANDEJA KRAFT MARRON + CALADO

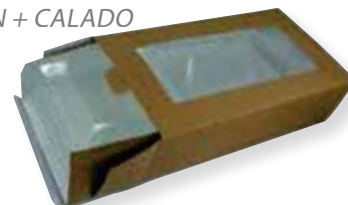

 340 x 180 x 90 mm  
 1200340  
 50+50  
(coffret+calage)



## LE COFFRET KRAFT BRUN



COFFRET KRAFT BRUN MICRO CANNELÉ AVEC FENÊTRE  
BANDEJA KRAFT MARRON

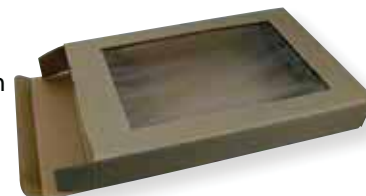

 450 x 290 x 70 mm  
 1201450  
 40



## LES PLATEAUX BOIS





PLATEAU BOIS 280 X 420 MM  
PLATO DE MADERA RECTANGULAR

 280 x 420 mm  
 BIO280420  
 100



PLATEAU RECTANGULAIRE BOIS (PEUPLIER)  
BANDEJA MADERA RECTANGULAR



 265x215x20 mm  
 BIO330265/C  
 250



## LES PLATEAUX RÉUTILISABLES

plateau Méla miné PERSONNALISABLE

PLATEAU FAST FOOD ECOLOGIQUE (MATÉRIAUX RECYCLÉS)  
BANDEJA ECOLOGICA FAST FOOD  
MATERIALES RECICLADOS)

 375 x 265 mm  
 11PLBIO  
 25





# ART DE LA TABLE



# ART DE LA TABLE



## L'ÉCOLOGIQUE / *SERVILLETA ECOLÓGICA*

### SERVLETTE MARRON CLAIR ÉCOLOGIQUE 30 X 30 CM 1 PLI *SERVILLETAS MARON CLARO ECOLÓGICO 30 X 30*

 30 x 30 cm  
 611113/C  
 3200 (16x200)









### SERVLETTE 100% RECYCLÉ KRAFT 2 PLIS *SERVILLETA DONLE PUNTO RECICLADA KRAFT*

   
 6132113 330 x 330 mm Kraft / marron 360 (12x30)  
 6132313 380 x 380 mm Kraft / marron 900 (18x50)

## LES SERVIETTES «NON TISSÉ» BIODÉGRADABLES 55 GR / *SERVILLETAS «NON TISSÉ»*



### SERVLETTE 40 X 40 CM / *SERVILLETAS 40 X 40 CM*

   
 BIO612131 blanc / blanco 720 (12x60)  
 6121342/C \* bordeaux / burdeos 720 (12x60)  
 6121322 crème / marfil 720 (12x60)  
 6121383 \* bleu foncé / azul marino 720 (12x60)

Êtes-vous sûr que ce n'est pas du tissu ?

Souplesse, douceur et résistance,  
hyper absorbant, tenue inégalée,  
aspect et touché textile.

Vous cherchez d'autres coloris ?  
N'hésitez pas à nous consulter !



Vous cherchez des idées pour décorer vos tables ?  
Découvrez notre site [www.axho.com](http://www.axho.com)















## LE QUALITATIF : SERVIETTES «2 PLIS» / *SERVILLETA «2 PLIS»*

SERVIETTES OUATE BIODÉGRADABLE 40 X 40 CM / *SERVILLETAS 40 X 40 CM*



			
 BIO6112321	blanc / blanco	2000 (16x125)	 BIO6112383
 BIO6112323	jaune / amarillo	2000 (16x125)	 bleu foncé / azul
 BIO6112341/C1	rouge / rojo	2000 (16x125)	 BIO6112393/C*
 BIO6112342	bordeaux / burdeos	2000 (16x125)	vert foncé/verde
 BIO6112321	crème / marfil	2000 (16x125)	2000 (16x125)

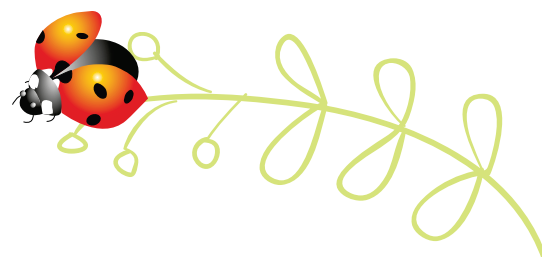

# ART DE LA TABLE C'est la ouate

## LE COMPROMIS : LES SERVIETTES DOUBLE POINTS COLORÉES / *SERVILLETA DOBLA PUNZADOS COLOREADA*

### SERVIETTE COCKTAIL 20 X 20 CM

SERVILLETAS DOBLE PUNTO



6132010 blanc / blanco

3000 (30x100)



6132011 noir / negro

3000 (30x100)



#### PERSONNALISATION

6132010 - à partir de 54 000 pièces

#### Le double point :

Volume et douceur. C'est une serviette en ouate qui grâce à son gaufrage sur toute la surface lui confère une qualité très absorbante et une bonne tenue, volume, douceur. Un carnaval de couleurs pour un grand classique de la serviette papier.



#### PERSONNALISATION

6132340 - à partir de 36 000 pièces



### SERVIETTE 38 X 38 M / *SERVILLETAS DOBLE PUNTO*



6132340/C blanc / blanco

1200 (24x50)



6132345 bleu marine / azul marino

1200 (24x50)



6132346 saumon / salmón

1200 (24x50)



6132341/C rouge / rojo

1200 (24x50)



6132342/C bordeaux / burdeos

1200 (24x50)



6132343 noir / negro

1200 (24x50)



6132393/C\* vert foncé / verde

1200 (24x50)



6132348 chocolat / chocolate

1200 (24x50)



61323931\* vert amande/almendra

1200 (24x50)



6132323\* jaune / yellow

1200 (24x50)



6132349 vert anis / verde

1200 (24x50)





### LES NAPPES RECTANGULAIRES «NON TISSÉ» 25 ET 50 M / LOS MANTELES RECTANGULARES «NON TISSÉ»

#### NAPPE RECTANGULAIRES 1,20 X 25 M / MANTEL «VOIE SÈCHE» EN ROLLO



Conditionnement : à l'unité



	632100	blanc / blanco
	632105	saumon / salmon
	632106	grège / crudo
	632107	champagne / champan
	632109	prune / ciruela
	632111	gris / gris
	632112	noir / negro



	632113	aubergine / berenjena
	632114	cacao / cacao
	632116	turquoise / tuquesa
	632115	parme / malva
	632117	fushia / fucsia*
	632122	jaune vif / amarillo*
	632123	rouge / rojo
	632124	bleu marine / azul oscuro

#### NAPPES RECTANGULAIRES 1,20 X 50 M / MANTEL «VOIE SÈCHE» EN ROLLO

Conditionnement : à l'unité



	632201	blanc / blanco
	632202	rouge / rojo
	632204/C	bordeaux / burdeos
	632206	bleu foncé / azul oscuro



	632207	champagne / marfil
	632203VP	vert kiwi / verde
	632296	cacao / cacao

### LES NAPPES VOIE SÈCHE RONDES ø 240 cm / LOS MANTELES PAPEL RONDAS



	632820	blanc / blanco	12
	632821	champagne / marfil	12
	632822	bordeaux / burdeos	12
	632823	bleu vif / azul brillante	12



	632824	vert pomme / verde	12
	632825	cacao / cacao	12
	632826	noir / negro	12





Vous aimez nos idées déco ?  
Toutes nos créations sur le site [www.axho.com](http://www.axho.com)



### LES CHEMINS DE TABLE VOIE SÈCHE 0,30 X 10 M / LOS CENTROS DE MESA

		3660667023667	ivoire / marfil		3660667023827	fushia / fucsia
		3660667023834	chocolat / chocolate		3660667023773	rouge / rojo
		3660667023711	tilleul		3660667023728	bordeaux / burdeos

### LES CHEMINS DE TABLE VOIE SÈCHE 0,40 X 10 M / LOS CENTROS DE MESA

		622902*	champagne / champagne / champan	4		632503	rose	4
		632501	cacao / cocoa / cacao	4		632504	bleu ciel/ blue / azul	4
		632500	vert kiwi / green / verde	4		632505	gris perle / grey / gris	4
		632502	parme / parma / malva	4				



### LES SETS PAPIER 30 X 40 CM / LOS SETS PAPEL

	623101	blanc / blanco	1000		623127*	parme / malva	1000
	623111	kraft brun / marron	500		623128	fuchsia / fucsia	1000
	623141/C	rouge / rojo	1000		623129*	prune / ciruela	1000
	623123/C	jaune vif / amarillo	1000		623132*	abricot / Albaricoque	1000
	623122*	chocolat / chocolate	1000		623142/C	bordeaux / burdeos	1000
	623125	vert amande / verde	1000		623143*	gris / gris	1000
	623126	mandarine / mandarín	1000		623191	vert foncé / verde	1000





### LES SERVIETTES BLANCHES 1 PLI / LAS SERVILLETAS BLANCAS 1 PLIEGUE

**SERVIETTE 1 PLI DÉCALÉ 30 X 30 CM**  
SERVILLETTA 1 CAPA DESPLAZADA

 30 x 30 cm  
 611112  
 3000





**SERVIETTE 30 X 30 CM**  
SERVILLETTA

 30 x 30 cm  
 611111/C  
 4000 (20x200)





### LES SERVIETTES BLANCHES 1 PLI POUR DISTRIBUTEUR / LAS SERVILLETAS BLANCAS PARA DISTRIBUIDOR

**SERVIETTE 1 PLI DÉCALÉ 25 X 30 CM**  
SERVILLETTA 1 CAPA 25 X30

 25 x 30 cm  
 SE2530B  
 10800 (36x300)





**SERVIETTE 1 PLI 30 X 33 CM**  
SERVILLETTA 1 CAPA 30 X 33

 30 x 33 cm  
 SE3333D  
 4000 (16x250)





### LES DISTRIBUTEURS / LOS DISTRIBUIDOR

**DISTRIBUTEUR SERVIETTE PETIT MODELE**  
DISTRIBUIDOR SERVILLETAS MODELO PEQUEÑO

 25 x 30 cm  
 XCPS12  
 1





**DISTRIBUTEUR SERVIETTE**  
DISTRIBUIDOR TOALLA

 33 x 33 cm  
 XCPS13  
 1





### LES SERVIETTES BLANCHES 2 PLIS / LAS SERVILLETAS BLANCAS 2 PLIEGUES

**SERVIETTE 30 X 30 CM**  
SERVILLETTA BLANCA

 30 x 30 cm  
 611211  
 3200 (32x100)





**SERVIETTE 2 PLIS BLANCHE 30 X 40 CM**  
SERVILLETTA 2 CAPAS BLANCA 30 X 40

 30 x 40 cm  
 611221/C  
 2400



**SERVIETTE 2 PLIS BLANCHE 40 X 40 CM**  
SERVILLETTA 2 CAPAS BLANCA 40 X 40

 40 x 40 cm  
 611231/C  
 2400 (24x100)



 PERSONNALISATION - mini : 48 000 pièces





### LES NAPPES PAPIER BLANC CARRÉ / RECTANGLE 60, 70 ET 80 CM

LOS MANTELES PAPEL BLANCO CUADRADAS Y RECTÁNGULOS

#### NAPPE 60 X 60 CM MANTEL 60 X 60 CM

 60 x 60 cm  
 623310  
 500

#### NAPPE 70 X 70 CM MANTEL 70 X 70 CM

 70 x 70 cm  
 623510  
 500

#### NAPPE 80 X 120 CM MANTEL 80 X 120 CM

 80 x 120 cm  
 6002381  
 250

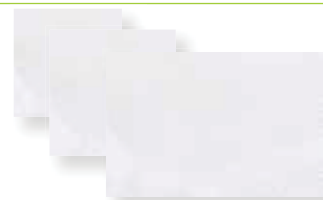



### LES NAPPES PAPIER BLANC RONDES Ø 80, 90, 100, 110 ET 120 CM / LOS MANTELES PAPEL RONDAS



#### NAPPE Ø 80 CM MANTEL

 Ø 80 cm  
 652110  
 250



#### NAPPE Ø 90 CM MANTEL

 Ø 90 cm  
 652210  
 250



#### NAPPE Ø 100 CM MANTEL

 Ø 100 cm  
 652310  
 250

#### NAPPE Ø 110 CM MANTEL

 Ø 110 cm  
 652410  
 250



#### NAPPE Ø 120 CM MANTEL

 Ø 120 cm  
 652510  
 250



### LES NAPPES PAPIER BLANC EN ROULEAU 10, 50 ET 100 M / LOS MANTELES PAPEL BLANCAS EN RODILLO

#### ROULEAU 1,20 X 10 M ROLLO

 1,20 x 10 m  
 20508  
 25

#### ROULEAU 1,18 X 50 M ROLLO

 1,18 x 50 m  
 603330/C  
 8

#### ROULEAU 1,18 X 100 M ROLLO

 1,20 x 100 m  
 603332/C  
 4



# MATÉRIEL ET HYGIÈNE

Pour vous accompagner dans vos cuisines et à l'extérieur.



## LES CALOTS ET LES CHARLOTES / LOS GORROS

CALOT PAPIER BLANC REGLABLE  
GORRO DE PAPEL BLANCO AJUSTABLE

 A96000  
 100



CHARLOTTE CLIP EN NON TISSÉ MEDIUM/LARGE  
GORRO CLIP NO TEJIDO MEDIANO/ANCHO

 D93112  
 100

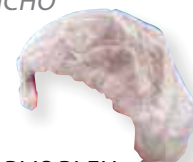

CHARLOTTE CLIP EN NON TISSÉ A VISIERE  
GORRO CLIP NO TEJIDO CON VISERA

 2131120  
 200



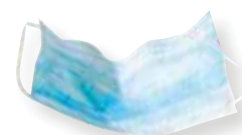

MASQUES ECONOMIQUE NON TISSÉ 3 PLIS BLEU  
MÁSCARAS ECONÓMICAS NO TEJIDAS 3 CAPAS

 100JT115  
 50



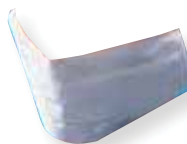

MASQUES PAPIER ECO 1 PLI BLANC  
MÁSCARAS DE PAPEL 1 CAPA BLANCA

 10PN49110  
 100



## LA TOUQUE ET LA CASQUETTE / LOS GORROS

TOUQUE PAPIER  
GORRO DE PAPEL

 h. 235 mm  
 A80000  
 50



CASQUETTE A RESILLE VISIERE  
GORA CON MALLA CON VISERA

 -  
 D89110  
 100





## LES BLOUSES / LAS BLUSAS

KIT VISITEUR comprenant :  
1 blouse blanche polyéthylène  
+1 charlotte blanche élastique  
+1 masque blanc 1 pli  
+ 2 surchaussures



KIT VISITA :

1 bata blanca polietilena  
+1 gorro blanco con elástico  
+ 1 máscara blanca 1 capa  
+ 2 cubre zapatos



 Taille unique / talla única  
 B10045/C  
 100



BLOUSE VISITEUR BLANCHE  
BLUSA BLANCA

 100JC090/C  
 144

BLOUSE NON TISSÉE PRESSION TAILLE XL AVEC POCHE  
BLUSA

 100JC013  
 50







# MATÉRIEL ET HYGIÈNE

Tous les accessoires obligatoires pour un établissement irréprochable.





## L'ESSUIE-MAIN / LA BAYETA

**BOBINE OUATE 2 PLIS 125 FORMATS**  
*BOBINA GUATA PEQUENA 2 CAPAS 125F*

 20 x 35 cm  
 125 formats  
 2312180  
 12







**ROULEAU ESSUIE-TOUT BLANC 50 FORMATS**  
*BOBINA COCINA BLANCA*

 23 x 22 cm  
 50 formats - 10 m  
 231300/C  
 40







**BOBINE OUATE 2 PLIS 450 FORMATS**  
*BOBINA GUATA 2 CAPAS*

 20 x 30  
 450 formats  
 2312450  
 6







**ESSUIE-MAIN TYPE MARATHON 2 PLIS PLIAGE EN Z**  
*SECAMANOS TIPO MARATÓN 2 CAPAS*

 23,3 x 23,3 cm  
 -  
 89386/C2  
 3840 (20x192)



**BOBINE OUATE 2 PLIS 1000FORMATS**  
*BOBINA GUATA 2 CAPAS 1000F*

 23,3 x 35 cm  
 1000 formats  
 23121000  
 2







**DISTRIBUTEUR MARATHON**  
*DISTRIBUIDOR MARATÓN*

 -  
 -  
 80311  
 1







**BOBINE OUATE 2 PLIS 1500FORMATS**  
*BOBINA GUATA 2 CAPAS 1500F*

 22 x 30 cm  
 1500 formats  
 23121500  
 2





**TORCHON TORCK BOITE DE 100 FORMATS**  
*TRAPO TORCK CAJA DE 100 FORMATO*

 42 x 38 cm  
 100 formats  
 3403300/C  
 5 boîtes de 100





## LE PAPIER HYGIÉNIQUE 2 PLIS / EL PAPEL HIGIÉNICO 2 PLIEGUES

**PAPIER HYGIÉNIQUE 2 PLIS JUMBO**  
*PAPEL HIGIÉNICO 2 CAPAS JUMBO*

 350 m  
 2322132  
 6 (1750 formats)





**PAPIER HYGIÉNIQUE 2 PLIS**  
*PAPEL HIGIÉNICO 2 CAPAS*

 200 m  
 2322211/C  
 108 (200 formats)



## LES SACS POUBELLE / LAS BOLSAS DE BASURA

**SAC POUBELLE BIODEGRADABLE 36µ**  
*BIODEGRADABLE BIN BAG 36µ*

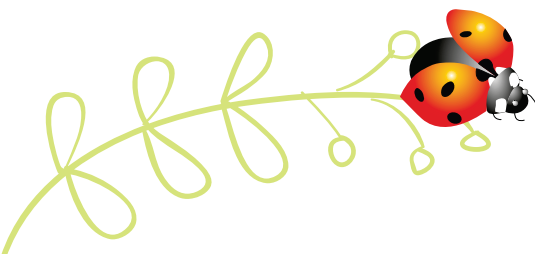

 110 L  
 BIO4403  
 100 (10x10)









# MATÉRIEL ET HYGIÈNE



## LES CAISSES CARTON / LAS CAJAS CARTÓN



### CAISSE CARTON GALIA CAJA DE CARTÓN GALIA

 60 x 40 x 30  
 350340  
 10



 40 x 30 x 30  
 350339  
 10



 30 x 20 x 20  
 350337  
 0



 60 x 40 x 20  
 350345  
 10



 40 x 30 x 20  
 350335  
 10



### CAISSE CARTON DOUBLE CANNELURE CAJA DE CARTÓN DOBLE SURCO

 25 x 18 x 14  
 350400  
 15

 50 x 50 x 40  
 350402  
 15

 120 x 80 x 85  
 350404  
 1

 30 x 20 x 17  
 350401  
 15

 60 x 40 x 40  
 350403  
 15



### CAISSE CARTON SIMPLE CANNELURE CAJA DE CARTÓN SIMPLE SURCO

 20x15x9  
 350330  
 1





## LES CAISSES CARTON POUR LE TRANSPORT / LAS CAJAS CARTÓN

### CAISSE TRAITEUR KRAFT BLANC CAJA DE PRESENTACIÓN KRAFT BLANCA

 660 x 450 x 100 mm  
 350336/C  
 30



### CAISSE TRAITEUR KRAFT BRUN CAJA DE PRESENTACIÓN KRAFT MARRÓN

 370 x 300 x 70 mm  
 350338KB  
 30



# BOULANGERIE



# BOULANGERIE

## LES SACS CROISSANT KRAFT BLANC / LAS BOLSAS CROISSANT KRAFT BLANCO



### SAC CROISSANT KRAFT BLANC DÉCOR PPT BOLSA CROISSANT KRAFT BLANCO PPT



N°1 120+35x180 mm 720001P 1000	N°2 120+35x210 mm 720002P 1000	N°3 140+50x210 mm 720003P 1000
N°4 140+70x280 mm 720004P 1000	N°5 200+50x280 mm 720005P 1000	Sac brioche 250+70x360 mm 720007P 500
N°6 200+50x360 mm 720006P 1000		

### SAC CROISSANT KRAFT BLANC BOLSA CROISSANT KRAFT BLANCO



N°1 120+40x150 mm 720001BL 1000	N°2 120+40x210 mm 720002BL 1000
N°3 140+60x210 mm 720003BL 1000	N°4 140+70x280 mm 720004BL 1000
N°5 200+60x280 mm 720005BL 1000	N°6 200+50x360 mm 720006BL 1000
Sac brioche 250+70x360 mm 720007BL 1000	



N°1 N°2 N°3 N°4 N°5 N°6 Sac brioche PPT

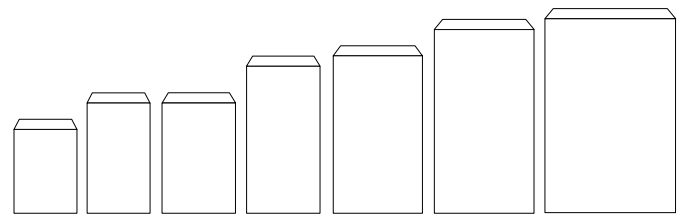

N°1 N°2 N°3 N°4 N°5 N°6 Sac brioche

## LES SACS CROISSANT KRAFT BRUN / LAS BOLSAS CROISSANT KRAFT MARRON



### SAC CROISSANT KRAFT BRUN BOLSA CROISSANT KRAFT MARRON



N°1 120+50x180 mm 720001KR 1000	N°2 120+40x210 mm 720002KR 1000
N°3 140+70x210 mm 720003KR 1000	N°4 140+70x280 mm 720004KR 1000
N°5 170+70x310 mm 720005KR 1000	N°6 190+70x360 mm 720006KR 1000
Sac brioche 250+70x360 mm 720007KR 1000	

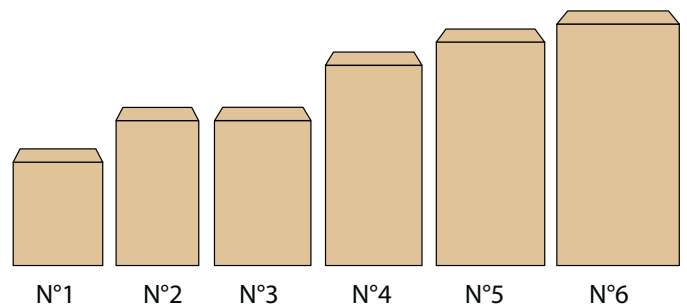

### LE SAC BRIOCHE / LA BOLSA BRIOCHE

#### SAC BRIOCHE BLANC PPT BOLSA BRIOCHE BLANCA PPT

300+90x430 mm 720008EP 500
----------------------------------



PERSONNALISATION : 1-2 couleurs à partir de 25 000 pièces / 3 couleurs 50 000 pièces / 4 couleurs avec aplat totl 100 000 pièces



## LES PAPIERS / LOS PAPEL

**PAPIER KRAFT BRUN**  
*PAPEL KRAFT MARRÓN*



 Ø 0,50x400 m  1 rouleau 15 kg	
 Ø 0,80x400 m  1 rouleau 24 kg	
 Ø 1,20x400 m  1 rouleau 36 kg	
 Ø 0,60x400 mm  1 rouleau 18 kg	
 Ø 1x400 mm  1 rouleau 30 kg	
 Ø 1,40x400 mm  1 rouleau 42 kg	
 Ø 1,60x400 mm  1 rouleau 48 kg	
 Bobino de 1000 mm - 72g  240008  au kg	
 Bobino de 650 mm - 64g  240001  au kg	
 Bobino de 600 mm - 90g  240013  au kg	

**PAPIER KRAFT BLANC DÉCOR PPT 45 G**  
*PAPEL KRAFT DÉCORADO 45G*



 Laize 335 mm  PAPENVOL35  1 bobine
 Laize 500 mm  PAPENVOL50  1 bobine

**PAPIER KRAFT BRUN INGRAISSABLE EN PAQUET DE 10KG**  
*PAPEL KRAFT MARRON*



 250x330 mm  210006I2535  paquet 10 kg	 400x600 mm  210006COUPE/C  paquet 10 kg
 350x500 mm  210003550KR  paquet 10 kg	

**PAPIER CUISSON**  
*PAPEL COCCIÓN*









 simple passage  400x600 mm  0173899  500 feuilles	 multi passage  400x600 mm  230005  500 feuilles
---	---

**MOUSSELINE DÉCOR PPT**  
*PAPEL MUSELINA DECORADO PPT*



 250x320 mm  230012  1 rouleau - 10 kg
 370x500 mm  2300123250  1 rouleau - 10 kg

**PAPIER INGRAISSABLE BLANC**  
*PAPEL BLANCO*

 250x350 mm  21000725/C  paquet 10 kg	 350x500 mm  21000732/C  paquet 10 kg
---	--

## LES CARRÉS CARTON BLANC / LAS BASES CUADRADA BLANCA





**OPALINE BLANCHE**  
*PAPEL OPALINA*



 Laize 350 mm  240007B35/C  1 rouleau - 10 kg
 Laize 500 mm  24000750/C  1 rouleau - 15 kg

**CARRÉ RAINÉ BLANC**  
*BASE CUADRADA BLANCA*



 110x110 mm  180000/C  250	 170x170 mm  180003/C  250
 150x150 mm  180002/C  250	 210x210 mm  180005/C  250
 190x190 mm  180004/C  250	
 130x130 mm  180001/C  250	 270x270 mm  180008  250

# EMBALLAGE BOUTIQUE

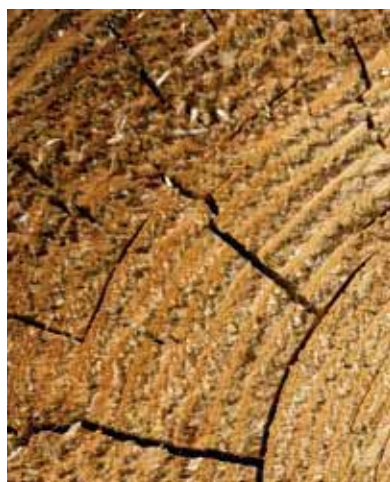

## L'EMBALLAGE BOUTIQUE

---



Firplast propose des gammes pulpe, PLA, carton et bois conditionnées spécialement pour la vente au détail. Les emballages sont adaptés et étiquetés avec code barre et descriptif, pour une identification optimale du produit dans les rayons.

# EMBALLAGE BOUTIQUE

## GAMME PULPE



### ASSIETTES PULPE

			
ASSIETTE PULPE RONDE	ø 17 cm	1151117/C2	25
ASSIETTE PULPE RONDE	ø 22,86 cm	1151122	25
ASSIETTE PULPE RONDE	ø 26 cm	1151126	25
ASSIETTE PULPE RONDE 3 COMPARTIMENTS	ø 26 cm	1151126/3	25
ASSIETTE PULPE RECTANGLE	13x26 cm	115211326	25
ASSIETTE PULPE CARRÉE	17x17 cm	1152117	25
ASSIETTE PULPE CARRÉE	21x21 cm	1152121	25
ASSIETTE PULPE CARRÉE	25x25 cm	1152125	25
ASSIETTE PULPE OVALE	23x32 cm	1154132	25
ASSIETTE PULPE OVALE	23x17 cm	1151123	25
ASSIETTE PULPE CARRÉE EMBLACEMENT VERRE	25x25 cm	1155125	25

### Gobelets PULPE

			
Gobelet PULPE	14 cl	BIO826140	25
Gobelet PULPE	20 cl	BIO826200	25
Gobelet PULPE	37 cl	BIO826300	25

### COQUILLES PULPE

			
COQUILLE PULPE	83x125x60 mm	145183/C	25
COQUILLE PULPE	200x200x60 mm	145170	25
COQUILLE PULPE	140x140x58 mm	145140/C	25
COQUILLE PULPE	200x150x78 mm	32402015	25
COQUILLE PULPE	240x155 mm	345232/C	25
COQUILLE PULPE	245x240x81 mm	145220	25

### PLATEAUX PULPE

			
PLATEAU PULPE	280x220x350 mm	1352822	50
PLATEAU PULPE	375x268x30 mm	1353827	50



# EMBALLAGE BOUTIQUE

## GAMME PLA

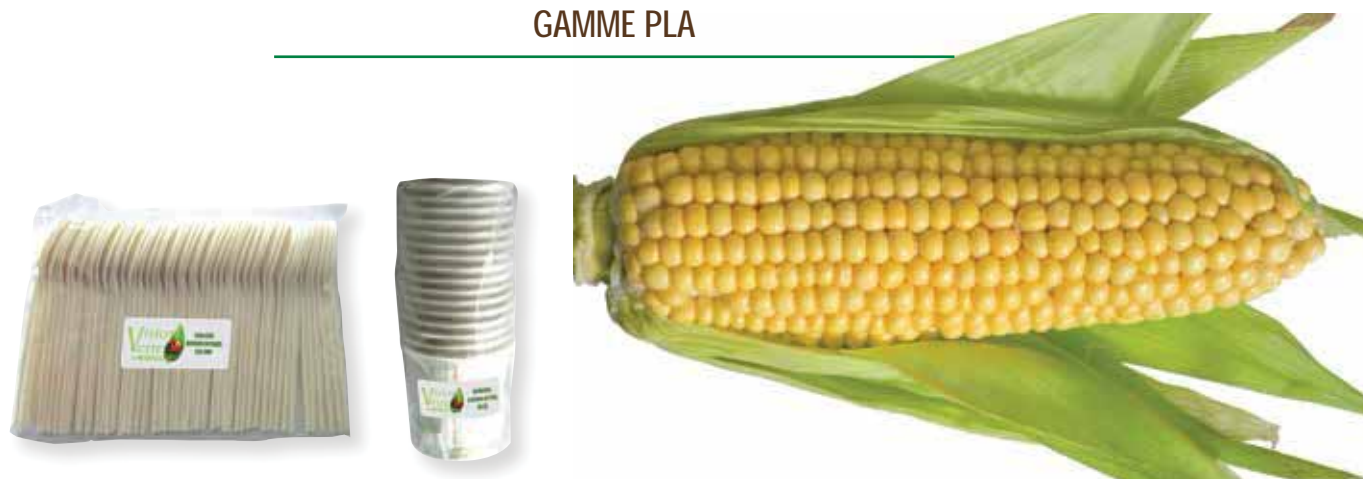

### Gobelets PLA Boisson Froide

			
GOBELET 20 CL CRISTAL PLA	20 cl	BIO820200	100
GOBELET 30 CL CRISTAL PLA	30 cl	BIO820300/C	70
GOBELET 40 CL CRISTAL PLA	40 cl	BIO820400/C	70
GOBELET 50 CL CRISTAL PLA	50 cl	BIO820500/C	60

### Gobelets Carton et PLA Boisson Chaude

			
GOBELET CARTON ET PLA 10 CL	10 cl	BIO800100/C	50
GOBELET CARTON ET PLA 20 CL	20 cl	BIO800200	50

### Couverts Amidon de Maïs

			
FOURCHETTE AMIDON DE MAÏS 165 MM	165 mm	BIO1511170/C	50
COUTEAU AMIDON DE MAÏS 165 MM	165 mm	BIO1521170/C	50
CUILLERE AMIDON DE MAÏS 165 MM	165 mm	BIO1531170/C	50





# EMBALLAGE BOUTIQUE

## GAMME CARTON



### GOBELETS CARTON KRAFT

GOBELET CARTON KRAFT BRUN 12CL  
 GOBELET CARTON KRAFT BRUN 18 CL  
 GOBELET CARTON KRAFT BRUN 30 CL



12 cl	8000178	120
18 cl	8000182	75
30 cl	8000179/C	60

### ASSIETTES CARTON

ASSIETTE EN CARTON BLANCHE Ø 15 CM  
 ASSIETTE EN CARTON BLANCHE Ø 18 CM  
 ASSIETTE EN CARTON BLANCHE Ø 23 CM



Ø 15 cm	111115	100
Ø 18 cm	111118	100
Ø 23 cm	111123	100



# EMBALLAGE BOUTIQUE

## GAMME BOIS



### ASSIETTES BOIS

			
ASSIETTE RONDE EN BOIS Ø 155 MM	Ø 155 mm	BIO116155/C	48
ASSIETTE RONDE EN BOIS Ø 190 MM	Ø 190 mm	BIO116190/C1	100
ASSIETTE RONDE EN BOIS Ø 215 MM	Ø 215 mm	BIO116215/C	100
ASSIETTE OCTOGONALE EN BOIS Ø 260 MM	Ø 260 mm	BIO116260	250
ASSIETTE BOIS RECTANGLE 195X140X30 MM	195x140x30mm	BIO330195/C	100
ASSIETTE BOIS RECTANGLE 265X215X20 MM	265x215x20 mm	BIO330265/C	250

### COUVERTS BOIS

			
FOURCHETTE EN BOIS 165 MM	165 mm	1591119	100
COUTEAU EN BOIS 165 MM	165 mm	1591219	100
CUILLÈRE À SOUPE EN BOIS 165 MM	165 mm	1591319	100
CUILLÈRE À CAFÉ EN BOIS 110 MM	110 mm	1591110/C	100
CUILLÈRE DESSERT EN BOIS 140 MM	140 mm	1591125/C	100
PIQUE NŒUD BAMBOU 70 MM	70 mm	1580070	100
PIQUE NŒUD EN BAMBOU 90 MM	90 mm	1580080	100
PIQUE NŒUD BAMBOU 100 MM	100 mm	1580105	100
PIQUE NŒUD BAMBOU 180 MM	180 mm	1580180	100
PIQUE DRAPEAU BAMBOU 105 MM	105 mm	158105	100
PIQUE DRAPEAU BAMBOU 150 MM	150 mm	158150	100
PIQUE DRAPEAU BAMBOU 180 MM	180 mm	158180	100
PINCE COCKTAIL EN BAMBOU 90 MM	90 mm	1581090	100
FOURCHETTE COCKTAIL BAMBOU 90 MM	90 mm	1580170	100

### BARQUETTES MISE EN BOUCHE BOIS

			
BARQUETTE BATEAU EN BOIS 7 CM	70 mm	BIO330070	100
BARQUETTE BATEAU EN BOIS 11,5X6,5 CM	115x65 mm	BIO330110	100
BARQUETTE BATEAU EN BOIS 17X8,5 CM	170x85 mm	BIO330170	100



# LE RECYCLAGE DES PRODUITS EN FIN DE VIE

Pour mettre en place «RecyPlast» avec FIRPLAST ,  
une seule adresse : [recyclage@firplast.com](mailto:recyclage@firplast.com)

## SOLUTION DE RECYCLAGE DES BARQUETTES «RECYPLAST»

Porté par l'évolution de la réglementation avec, entre autre, le Grenelle de l'Environnement, les incitations à la réduction des déchets et la promotion du recyclage, la restauration collective a elle aussi pris conscience de ces enjeux et intègre, dans sa démarche, les achats éco-responsables.

FIRPLAST en tant que partenaire privilégié des collectivités depuis plus de 20 ans a mis en place RecyPlast, une solution simple pour le recyclage des barquettes usagées.

FIRPLAST s'appuie sur son réseau de partenaires locaux pour la collecte et de traitement de vos barquettes usagées. Avec un point de collecte éloigné de moins de 50 km, le transport est limité au strict minimum et le bilan carbone optimisé.

Ainsi à chaque étape du traitement de la fin de vie de vos barquettes alimentaires, FIRPLAST vous accompagne et vous propose un partenariat sur les étapes clés de votre démarche :

- Vente de caisses de stockage , gerbables et pliables
- Location/vente de broyeur
- Transformation et régénération des matières plastiques.

Aujourd'hui, l'empreinte écologique de toutes activités est devenue une évidence. Les enjeux sont colossaux et chaque entreprise, chaque administration et chaque particulier a modifié son approche de la consommation et surtout, de «l'après-consommation» : la fin de vie du produit.



# PRINCIPE DE FONCTIONNEMENT «RECYPLAST»



# PRINCIPE DE FONCTIONNEMENT «RECYPLAST»

## TRANSFORMATION ET RÉGÉNÉRATION DES MATIÈRES PLASTIQUES



# INFORMATIONS TECHNIQUES MATIÈRES

		CODE	MATIÈRE	TEMPÉRATURE MINI / MAXI	MICRO-ONDABLE	FOUR TRADITIONNEL	COMPOSTABLE	BIODÉGRADABLE	RECYCLABLE
	PEUPLIER	Bois	-18°C à +220°C	NON	OUI	OUI	OUI	OUI	
	PIN	Bois	-5°C à +70°C	NON	NON	OUI	OUI	OUI	
	PULPE 	Résidu canne à sucre	-18°C à +150°C	OUI	OUI	OUI	OUI	OUI	
	BAMBOU	Pohaceae (herbacé)	-5°C à +70°C	NON	NON	OUI	OUI	OUI	
	PLA TRANSPARENT 	Plastique acide polyactique	-18°C à +40°C	NON	NON	OUI	OUI	OUI	
	CPLA TRANSPARENT 	Amidon de maïs	jusqu'à 80°C	NON	NON	OUI	OUI	OUI	
	CARTON	—	-40°C à +80°C	OUI	NON	OUI	OUI	OUI	
	LIAISON VERTE 	Pure pâte avec protection de surface en cellulose	-40°C à 175°C	OUI	OUI	OUI	OUI	OUI	
	APET - PET RPET - PETE	Polyéthylène teraphthalate	-40°C à +70°C	NON	NON	NON	NON	OUI	

# PERSONNALISATION

## Conditions générales de personnalisation

Toute commande de produits personnalisés est soumise à des contraintes spécifiques, à savoir :

Le projet doit faire l'objet d'un devis précis, valable 1 mois et irrévocable à dater de la commande.

Ce devis peut être accompagné selon votre demande d'échantillon et pré-maquette à plat avec indication du n° de la couleur Pantone.

Des frais techniques pour une première exécution sont à prévoir.

### PRIX ET QUANTITÉ

La quantité est une indication par référence, par dessin et par format. Elle peut varier selon les produits de +/- 10% à +/- 20%. C'est cette quantité livrée qui sera facturée et aucune réclamation ne pourra être formulée.

### DÉLAI

Le délai de réalisation démarre à compter du retour du « bon à tirer » signé.

Il varie entre 4 et 12 semaines selon les produits et sera précisé lors du devis.

Tout délai qui, malgré nos efforts, n'aura pu être respecté ne sera, en aucune façon, un motif d'annulation de commande ou d'indemnisation quelle qu'elle soit.

De même pour les teintes choisies qui peuvent être altérées par la porosité ou la couleur du support. Cela n'engendrera aucune indemnisation ou rabais.

### RÈGLEMENT

Ces commandes spéciales sont payables :

- 50% à la commande
- 50% à la livraison

### ANNULATION

L'annulation ne peut avoir lieu qu'avant la mise en fabrication.

L'acompte sera, dès lors, restitué déduction faite des frais déjà engagés au moment où l'annulation intervient.

Note : les maquettes soumises à approbation restent la propriété de FIRPLAST / GEREMBAL tant que la commande n'est pas confirmée.

## PAO

Imprimez votre image de marque sur de nombreux produits. Avec Firplast des milliers de combinaisons possibles.

Vous pouvez choisir votre couleur de fond, imprimer votre logo.

Mise au net de votre logo sur différents supports : gobelet, serviette, sacherie, boîlage...

Notre service PAO, avec son bureau d'étude et ses logiciels spécialisés dans les arts graphiques, conçoit tous types de projets, de la création à la fabrication.

Nous maîtrisons chaque étape de la chaîne graphique.



**CONSULTEZ-NOUS  
POUR UN DEVIS  
PERSONNALISÉ**

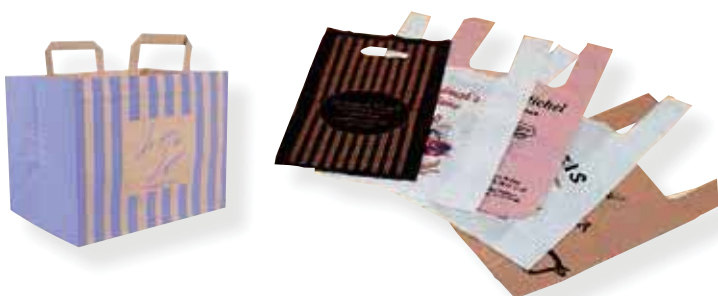

# PERSONNALISATION

## PERSONNALISATION DE VOS SACS SANDWICHS ET SACS À EMPORTER

Bénéficiez d'une plus grande diffusion de votre marque en personnalisant vos sacs sandwichs, vos sacs à emporter etc...

## LA PERSONALIZACION DE SUS BOLSAS SANDWICHS Y BOLSAS PARA LLEVAR.

POSIBILIDAD DE HACER IMPRIMIR SUS BOLSAS CON EL NOMBRE DE SU EMPRESA.

### SACS SANDWICHS PAPIER

BOLSAS DE BOCADILLO EN PAPEL

Quantité min. / Cantidad mínima 25 000  
Nb couleurs max. / Colores 3  
Frais de clichés / Coste clisé consultez-nous / consultar



PERSONNALISATION - mini : 25 000 pièces



### SACS SANDWICHS TRANSPARENT

BOLSAS SANDWICH TRANSPARENTE

Quantité min. / Cantidad mínima 10 000  
Nb couleurs max. / Colores 2  
Frais de clichés / Coste clisé consultez-nous / consultar



PERSONNALISATION - mini : 10 000 pièces



### SACS CABAS

BOLSAS VENTA PAR LLEVAR

Quantité min. / Cantidad mínima 25 000  
Nb couleurs max. / Colores 6  
Frais de clichés / Coste clisé consultez-nous / consultenos



PERSONNALISATION - mini : 25 000 pièces





# CONDITIONS GÉNÉRALES DE VENTE

## 1. APPLICATION DES CONDITIONS GÉNÉRALES – DÉFINITIONS

(a) Toute vente conclue et toute commande acceptée par FIRPLAST (ci-après « le vendeur ») sont régies par les conditions particulières de vente figurant sur les offres, acceptations de commandes ou contrats de vente du Vendeur ainsi que par les présentes conditions générales de vente (lesquels documents ne pourront être modifiés que par écrit nonobstant toutes clauses contraires pouvant figurer dans les conditions particulières ou les conditions générales d'achat de l'Acheteur.

(b) Le terme « Produits » signifie les produits mis en vente par le Vendeur.

## 2. OFFRES

Les offres du Vendeur sont faites sous réserve que les produits offerts soient disponibles au moment de la réception de la commande de l'Acheteur.

## 3. ACCEPTATION DES COMMANDES

(a) Toute commande est réputée acceptée par le vendeur et constitue une vente ferme dès remises des Produits au transporteur choisi par le vendeur dans le cas où celui-ci en assure le transport ou remise à l'Acheteur ou à son transporteur si l'Acheteur assure le transport desdits Produits.

(b) Aucune vente ferme ne pourra être annulée par l'Acheteur.

## 4. LIVRAISON – RISQUES – TRANSPORT – RÉCEPTION

(a) Les Produits sont livrés et Vendus par le Vendeur soit franco magasin de l'Acheteur soit départ magasin du Vendeur si l'Acheteur en assure le Transport. Si la commande n'atteint pas le montant du franco prévu dans les conditions particulières de vente l'expédition donne lieu à une facturation forfaitaire.

Les produits sont transportés aux risques et périls de l'Acheteur bien que le transfert de propriété en soit différé, conformément à la Clause 7 (Réserve de propriété) ci-dessous.

(b) Pour les ventes franco magasin de l'Acheteur, le Vendeur se charge du transport et de l'assurance des Produits. L'intervention du Vendeur dans la détermination ou l'exécution du transport et dans l'assurance des Produits ne confère en aucun cas au Vendeur la qualité de commissionnaire de transport ou de transporteur.

(c) Pour les ventes départ magasin du Vendeur, l'Acheteur est responsable du transport et de l'assurance des Produits.

(d) Dans le cas où les produits sont vendus franco magasin de l'acheteur, la réception des produits par l'acheteur annule toute réclamation contre le vendeur pour dommages, avaries ou manquants, sauf si l'acheteur notifie ses réserves au transporteur par lettre recommandée avec avis de réception dans un délai de trois jours [non compris les dimanches et jours fériés] suivant la réception des produits constatée par le récépissé délivré au transporteur et qu'il adresse une copie de cette notification au vendeur dans le même délai.

(e) Dans les cas où les Produits sont vendus départ magasin du Vendeur, la réception des Produits par l'Acheteur ou son transporteur au magasin du Vendeur met un terme à toute réclamation contre le Vendeur pour dommages, avaries ou manquants, sauf si cette réclamation parvient au Vendeur par lettre recommandée avec avis de réceptions dans un délai de trois jours francs [non compris les dimanches et jours fériés] suivant ladite réception des Produits.

(f) En cas de livraison « contre remboursement » l'Acheteur doit établir le chèque au nom FIRPLAST. En aucun cas, le chèque ne doit être établi au nom du transporteur.

(g) Les produits sont livrés dans des emballages (cartons ou sachets) standards de différents modèles comprenant chacun un nombre donné d'unités de Produits. Si le nombre d'unités de produits commandées par l'Acheteur ne correspond pas au nombre d'unités contenues dans l'un quelconque des emballages standards du Vendeur, le Vendeur livrera le nombre d'unités le plus proche en fonction du conditionnement [en plus ou en moins] et l'Acheteur sera tenu d'en accepter la livraison au prix facturé pour le nombre d'unités considérées, sans pouvoir réclamer aucune indemnisation au Vendeur. Il est entendu que si le nombre d'unités livrées est inférieur au nombre d'unités commandées pour la raison indiquée ci-dessus, cette différence ne pourra en aucun cas constituer un « manquant » au sens des paragraphes (d) et (e) ci-dessus.

## 5. PRIX

Le prix des Produits sera celui du tarif du Vendeur en vigueur à la date de livraison. Toutefois, si ce prix excède de plus de 10 % le prix en vigueur à la date de la commande de l'Acheteur, l'Acheteur pourra, par dérogation à la Clause 3 ci-dessus, annuler sa commande, à la condition (a) qu'il retourne préalablement au Vendeur tous Produits livrés et (b) que lesdits Produits soient en parfaite condition de vente. La présente Clause 5 ne s'appliquera pas aux commandes de Produits sur lesquelles des inscriptions [« spécial print »] ou des motifs graphiques [« artwork »] spéciaux doivent être apposés à la demande de l'Acheteur.

## 6. CONDITIONS DE PAIEMENT

(a) Sauf clause contraire dans les conditions particulières de vente du vendeur, le prix des Produits est payable comptant (« contre remboursement ») dès la réception des Produits par l'Acheteur en ses magasins ou leur réception par l'Acheteur ou son transporteur dans les magasins du Vendeur si l'Acheteur en assure le transport.

(b) Lors d'une première commande un acompte de 50% du prix des Produits alors en vigueur est exigible à la commande.

(c) En cas de non paiement de tout ou partie du prix à son échéance ou de non acceptation d'une traite, le cas échéant, la totalité du prix des produits ou du solde restant dû deviendra, immédiatement et de plein droit, exigible, sans qu'il soit besoin au préalable d'une mise en demeure ou d'aucune procédure judiciaire et sans préjudice de la Clause 7 (Réserve de propriété) et de la Clause 10 (Résolution de la vente) ci-après.

Toute somme ou tout ou partie du prix des Produits due par l'Acheteur et non payée à sa date d'exigibilité porte intérêt de plein droit à partir de cette date et sans mise en

demeure, au bénéfice du Vendeur, à un taux égal à trois fois le taux d'intérêt légal. De convention expresse et sauf report sollicité en temps et accordé par FIRPLAST, toute somme non payée à l'échéance figurant sur la facture entraîne immédiatement et de plein droit :

\_ l'exigibilité des termes suivants ainsi que tout montant restant dû,

\_ la suppression des avantages qui auraient pu être consentis antérieurement, et, notamment la suppression des délais de règlement accordés dans les conditions particulières,

\_ l'interruption de toute livraison en cours ou à venir,

\_ le droit, pour FIRPLAST, de reprendre les marchandises déjà livrées et non payées dans les conditions exposées ci après. En cas de recouvrement par voie contentieuse, les sommes dues pourront être majorées de 15%, à titre de clause pénale en sus des éventuels frais judiciaires.

Les traites impayées à leur date d'échéance seront, en outre, majorées, en cas de nouvelle présentation, des intérêts et frais occasionnés par leur retour et la nouvelle mise en circulation.

## 7. RÉSERVE DE PROPRIÉTÉ

Les produits restent la propriété du vendeur jusqu'au paiement complet de leur prix par l'acheteur. L'acheteur assume les risques de perte et d'avaries des produits dès leur départ du magasin du vendeur. Le vendeur aura le droit de reprendre les produits vendus, sur simple mise en demeure, si l'intégralité de leur prix (tva comprise) n'a pas été payée à sa date d'exigibilité.

## 8. GARANTIE

La garantie des vices cachés des Produits par le Vendeur est limitée au remplacement gratuit des Produits reconnus défectueux par le Vendeur, sous réserve de leur bon usage, à l'exclusion de tous dommages et intérêts, sauf si la garantie consentie au Vendeur par le fabriquant est moins favorable, auquel cas, cette dernière seule sera applicable à l'Acheteur.

## 9. RESPONSABILITÉ – DÉLAI DE LIVRAISON – CLAUSE ÉTRANGÈRE

(a) Le Vendeur s'efforce de livrer les Produits à l'Acheteur dans les meilleurs délais. Toutefois, les délais mentionnés à l'Acheteur ne le sont qu'à titre indicatif. Le Vendeur n'est donc pas responsable en cas de retard de livraison.

(b) En cas d'inexécution totale ou partielle par le Vendeur de ses obligations, la responsabilité du Vendeur sera limitée au préjudice direct (à l'exclusion du manque à gagner) subi par l'Acheteur du fait de cette inexécution.

(c) Le Vendeur ne sera responsable de l'inexécution totale ou partielle de ses obligations si cette inexécution résulte d'un cas de force majeure ou d'une cause qui lui est étrangère ou qui est indépendante de sa volonté même si cette cause n'a pas le caractère de force majeure (tel que, mais que cette liste soit limitative, le cas de grève, lock-out, guerre, acte de terrorisme, incendie, catastrophe naturelle, accident, embargo, réquisition, nationalisation, mesures législatives ou règlement aires promulguées par les autorités gouvernementales).

## 10. RÉSOLUTION DE LA VENTE

(a) Sans préjudice de ses droits selon la Clause 6 (Conditions de paiements) ou la Clause 7 (Réserve de propriété) ci-dessus, le Vendeur pourra résilier la vente des Produits en cas de non paiement par l'Acheteur, à sa date d'exigibilité, de tout ou partie de leur prix et / ou de la TVA s'y afférent ou de toute autre somme due.

(b) Sans préjudice de ses droits selon la Clause 6 (Conditions de paiements) ou la Clause 7 (Réserve de propriété) ci-dessus, le Vendeur pourra résilier la vente en cas d'inexécution par l'Acheteur de l'une quelconque de ses obligations vis-à-vis du Vendeur ou en cas de cessation des paiements, règlement judiciaire, liquidation des biens, suspension provisoire des poursuites, ou toutes procédures semblables, dissolution amiable de l'Acheteur ou, généralement, si celui-ci cesse son activité pour quelque cause que ce soit.

(c) La résolution de la vente selon cette Clause 10 sera acquise de plein droit immédiatement, par simple lettre recommandée avec avis de réception, sans mise à demeure ni procédure judiciaire préalable quelconque et le Vendeur pourra reprendre possession des Produits objet de la vente résolue, sans préjudice de tous dommages et intérêts.

## 11. MODIFICATION DES PRODUITS

Le Vendeur se réserve le droit de modifier les Produits, y compris leur composition et leur emballage, dans le but d'y apporter des améliorations ou de se conformer à la réglementation en vigueur.

## 12. EXÉCUTION DES COMMANDES

Le Vendeur ne sera pas tenu d'honorer les commandes des Produits (a) dont la production aura été définitivement interrompue ou que lui-même ou l'une des sociétés de son groupe n'aura plus le droit de fabriquer et/ou de vendre ou (b) dont la livraison serait devenue démesurément onéreuse à la suite des modifications de toute réglementation en vigueur, française ou étrangère et/ou (c) dans le cas où le Vendeur serait en liquidation ou aurait cessé toute activité. Dans les cas précédents, l'Acheteur ne pourra réclamer aucun dommage-intérêt au Vendeur.

## 13. ATTRIBUTION DE COMPÉTENCE

En cas de litige relatif à la vente des Produits et à ses suites, les Tribunaux de LYON seront seuls compétents même en cas de pluralité de défendeurs ou d'appel en garantie et quelles que soient les modalités de paiement.



# Ingénierie

## RECHERCHES & DEVELOPPEMENT

- Nous sommes là pour répondre à tous vos besoins ainsi qu'à votre cahier des charges point par point.
- Nous créons un design innovant, attrayant, qui facilite l'utilisation de votre produit. Ainsi, le développement ingénierie permet de réaliser toutes vos envies.
- Enfin, nous concrétisons vos projets à l'aide de plans techniques et rendus réalistes en 3D.
- Pour toute commande, nous vous offrons la possibilité de visualiser les projets grâce au prototypage.

De l'étude ...

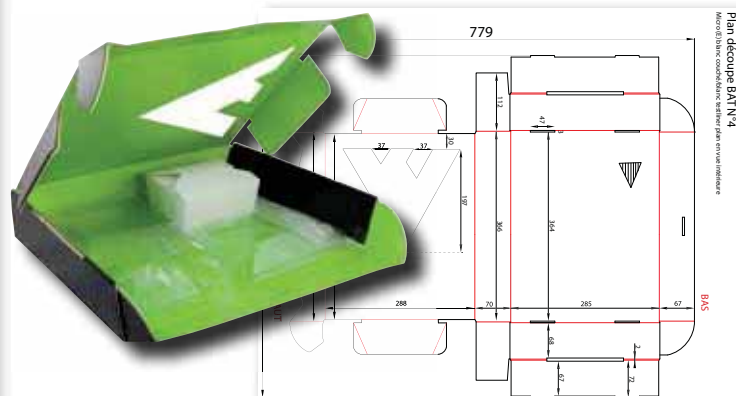
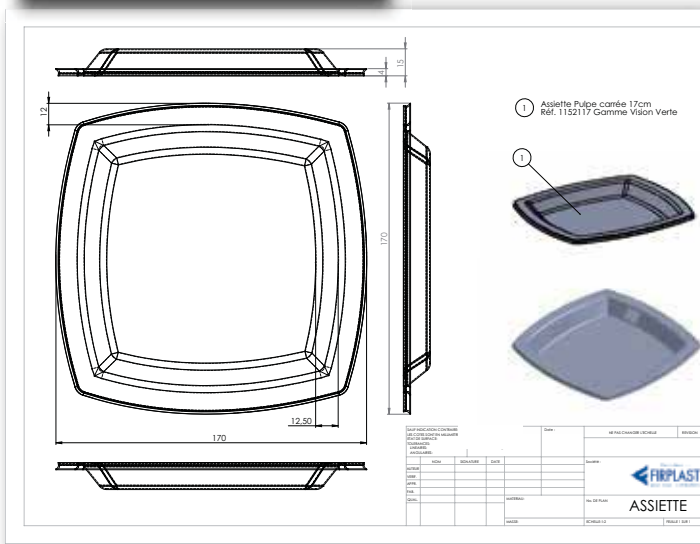
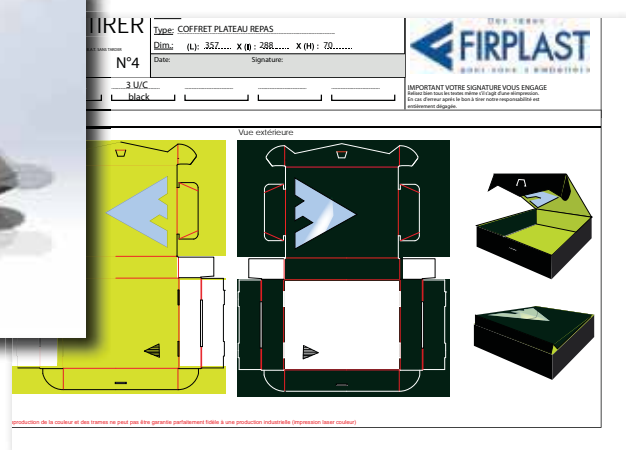
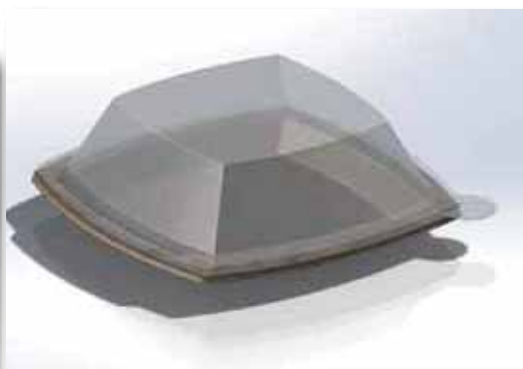

# Création graphique

## PERSONNALISATION

- Nous analysons votre cahier des charges : le type de produit à personnaliser, la quantité souhaitée, le délai, le visuel à imprimer et le nombre de couleurs.
- Nous créons pour vous les bons à tirer sur gabarit en établissant une recherche colorimétrique, formelle et typographique.
- Après validation sur épreuve papier, nous permettons à vos projets de voir le jour.



5



6



... à la personnalisation

# e-commerce

## MISE EN LIGNE

- Pour vous, nous organisons la présentation de nos produits, leur mise en situation, leurs caractéristiques techniques, leurs conditionnements et leurs «Plus».
- Nous mettons à jour l'actualité de nos produits afin de vous offrir un maximum de choix et de nouveautés.
- Enfin, nous optimisons les moteurs de recherches et les options de navigation pour faciliter votre requête.



## Nos collections - Nuestras gamas



- Tenue de soirée -

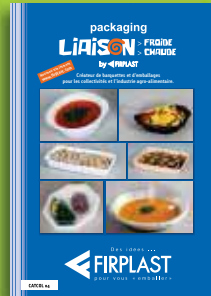

- Liaison froide -



- Nomade -

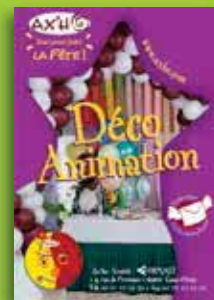

- Décoration -

## Nos sites internet - Nuestros sitios internet



[www.firplast.com](http://www.firplast.com)



[www.vision-verte.com](http://www.vision-verte.com)



[www.axho.com](http://www.axho.com)



[www.interface-packaging.fr](http://www.interface-packaging.fr)

### FIRPLAST LYON

4, rue de Provence - 69800 ST-PRIEST  
Tél. 04 72 23 66 66 - Fax 04 78 20 54 40  
contact@firplast.com - www.firplast.com

### FIRPLAST MARSEILLE

2 rue de Isaïa - Les Chutes Lavie - 13013 MARSEILLE  
Tél. 04 96 13 06 50 - Fax 04 96 13 06 51

### FIRPLAST LANGUEDOC

MIN de Montpellier - Boîte n°16 - 281, av. du Marché Gare  
34070 MONTPELLIER  
Tél. 04 67 58 34 00 - Fax 04 67 58 50 37

### FIRPLAST BORDEAUX

Rue Jean Raymond Guyon Z.I. - 33310 LORMONT  
Tél. 05 56 31 66 57 - Fax 05 56 74 60 42

### STE PAPIER RUSÉ société adhérente indépendante

32, avenue du Grugliasco - 38130 ECHIROLLES  
Tél. 04 76 62 79 32 - Fax 04 76 24 44 32

### LE SPÉCIALISTE

PME - PMI de Rivière Riche - Boîte 144 - 97200 FORT DE FRANCE - MARTINIQUE DE L'EMBALLAGE  
Tél. 05 96 50 78 80 - Fax 05 96 50 56 55

### GEREMBAL ANTILLES

### APPRO EMBAL

Moundong Sud 97122 Baie Mahault - GUADELOUPE  
Tél. 05 90 32 78 18 - Fax 05 90 32 78 08

### PINESGA BUSINESS GROUP. SL

SABADELL - BARCELONA  
Tél. +34 937457193 - Fax +34 937253799 - ESPAGNE

